

Accessory Dwelling Unit State Law Changes (For Now)

**Thursday, July 14, 2020
City Council Presentation**

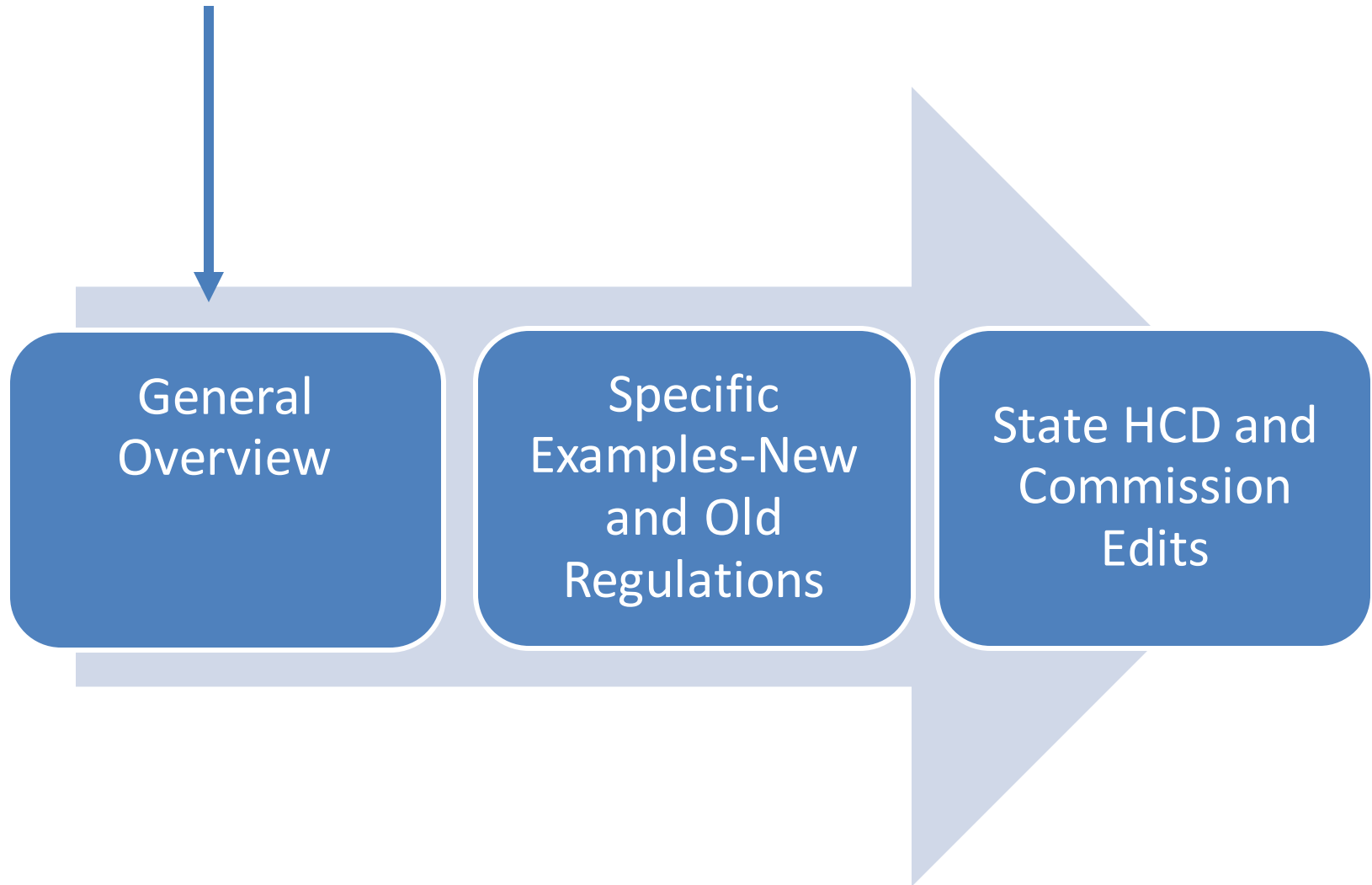

Presentation



Credentials

- AICP
- 17 years of urban planning experience
- Third time rewriting an ADU ordinance



Jobs to Housing Imbalance

- **55,000 Jobs/7,000 Housing Units in the past 12 months**
- **Santa Clara GDP was 316 Billion dollars in 2018**
- **The entire State of Colorado's GDP was 341 Billion dollars**

The State Strikes Back

SB 13

AB 670

AB 587

?????

AB 68

AB 881

AB 671

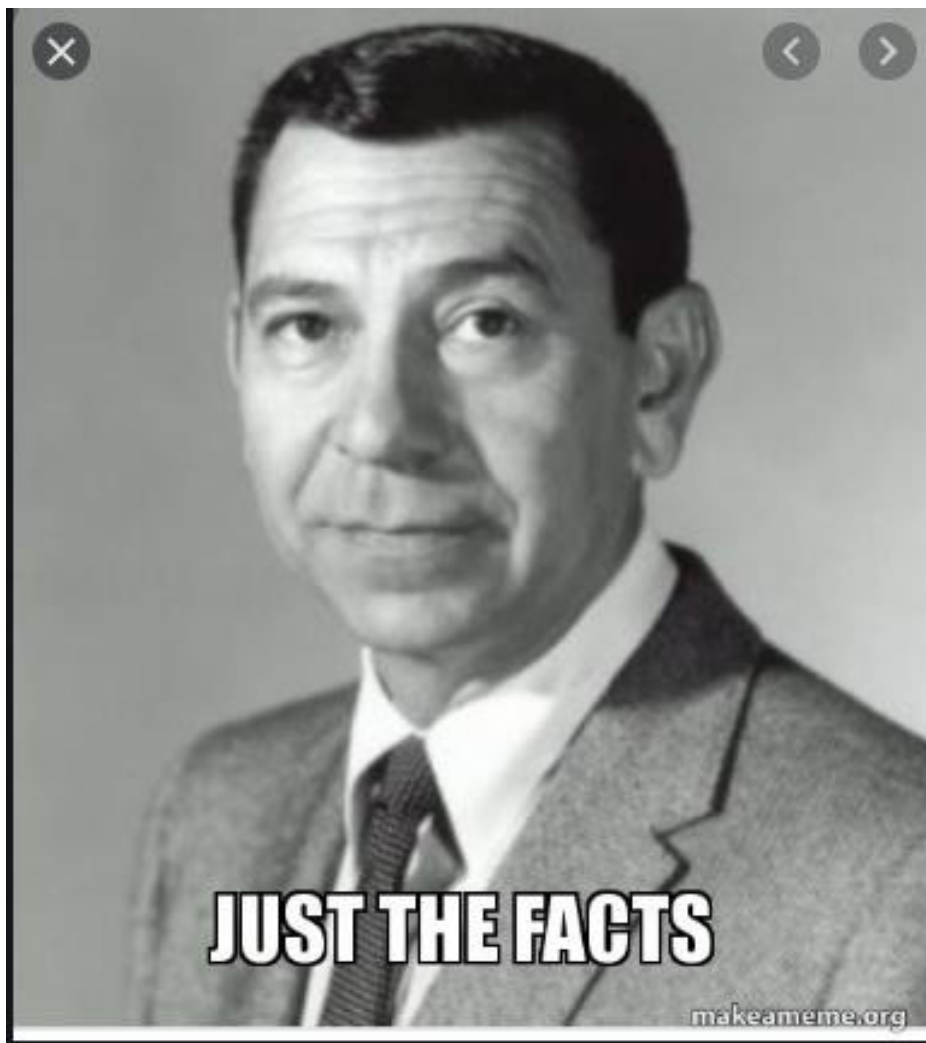

JUST THE FACTS

makeameme.org

Summary of Legislation

SB 13

Impact fees can't be assessed on units that are less than 750.

ADUs can be counted toward your RHNA number

If the garage is converted, replacement parking can't be required.

Summary of Legislation

AB 68

Lot coverage and lot size can't be used as a determinate factor within an ADU ordinance

ADU application must be approved within 60 days of a complete application, unless construction is apart of the main structure

Prohibits using lot coverage, FAR, open space or other design standards if doing so doesn't allow at least an 850 square foot ADU. The 850 can be above what is allowed by the zoning district

Summary of Legislation

AB 670

CCNRs are voided if they prohibit the building of ADUs

AB 671

City's must create a plan within their Housing Element to incentive and promote ADUs

Size of Units

850 Sq. Ft- Detached or Attached.

(800 certain sections of the legislation)

ADU By Right. 500 Sq. Ft. JADU By Right within the confines of the house

Parking Requirements

No parking requirement for a JADU

No parking requirement for an ADU if within an existing carport, garage

No parking requirement for an ADU if near transit or apart of a car share vehicle program

Kitchen and ADUs

ADU-(n) A kitchen shall be provided for an accessory dwelling unit. A full kitchen requires habitable space used for preparation of food that contains at least a sink, a refrigerator of no less than 10 cubic feet, and either a cooktop and an oven, or a range. A food preparation counter and storage cabinets that are of reasonable size in relation to the size of the ADU are also required.

JADU-A cooking facility with appliances. Appliances can include hot plate, or counter-top cooking. A property owner does not need to have a wall-installed oven or stove to qualify for cooking appliances.

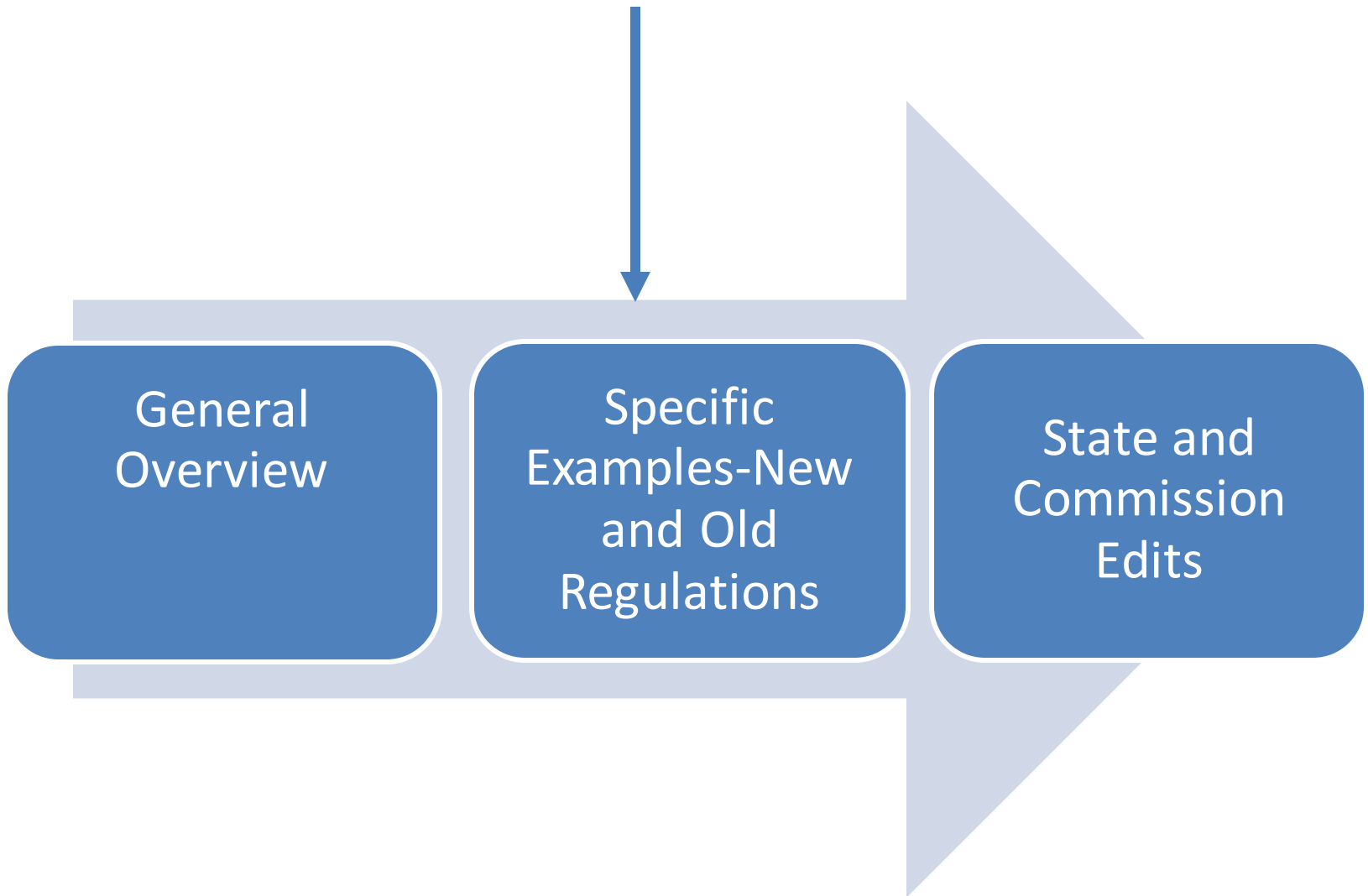

Visual Diagrams
Not to Scale

Current Los Altos Detached ADU Standards

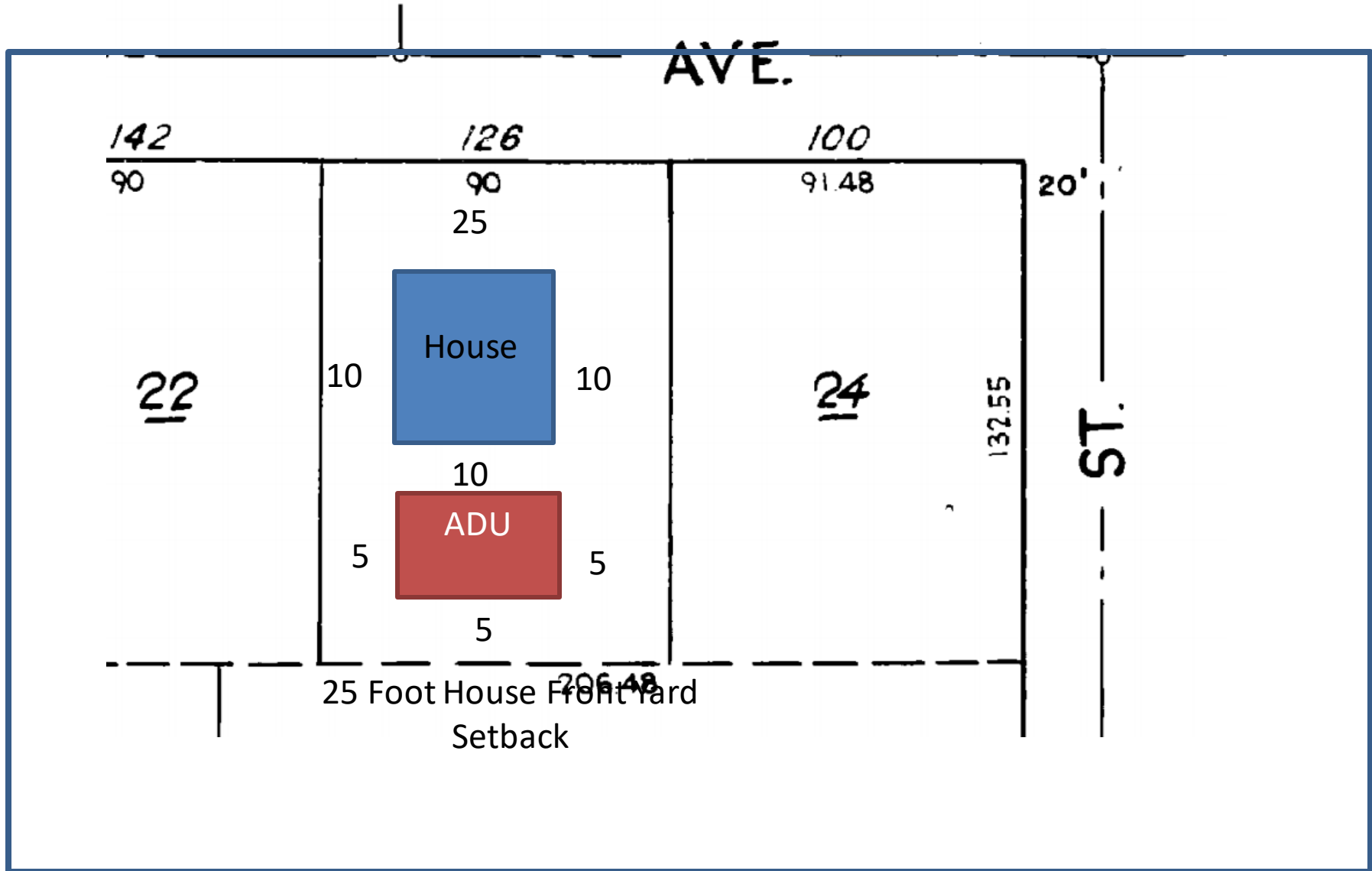

Los Altos Current Daylight Plane Diagram-ADUs and Accessory Structures

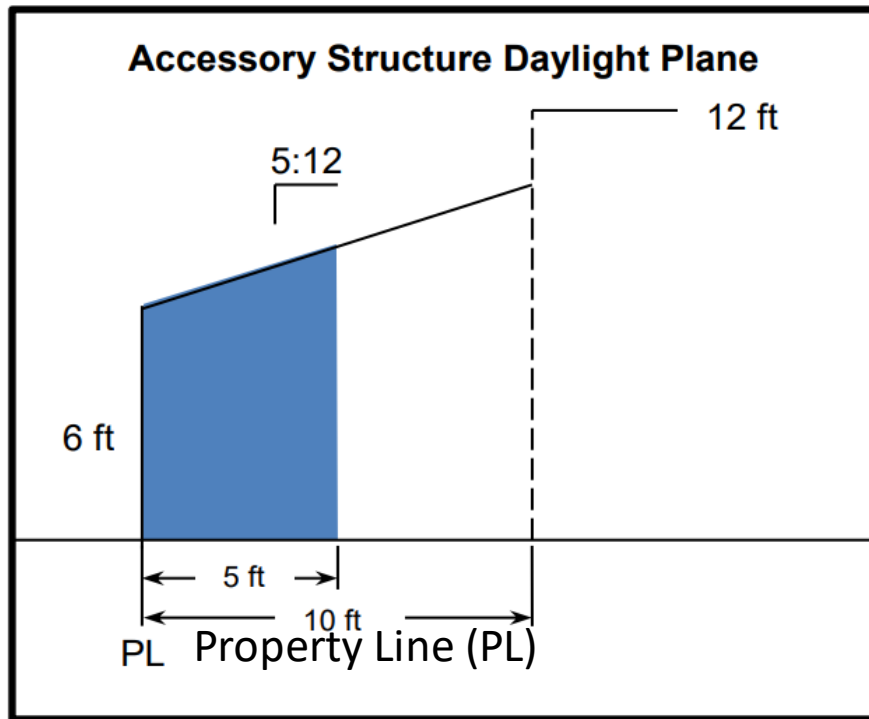

The daylight plane starts at a height of six feet at the property line and proceeds inward at a 5:12 slope to a distance of ten (10) feet from the side and rear property lines;

All appurtenances, including chimneys, vents and antennas, shall be within the daylight plane;

C. The daylight plane is not applied to a side or rear property line when it abuts a public alley or public street.

require a separation of at least 10 feet from the main house

Attached Interior Lot ADU

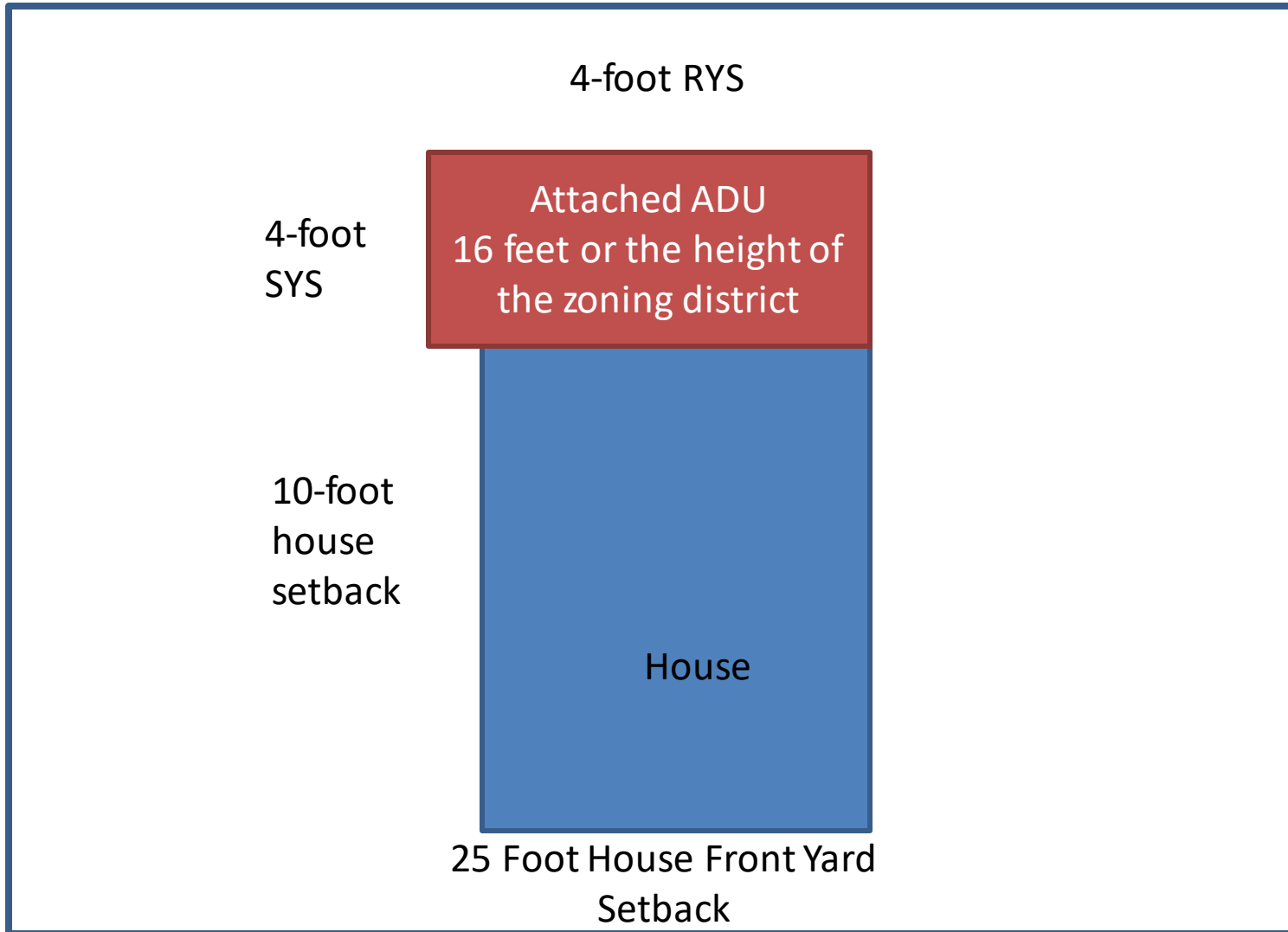

Attached Corner Lot ADU

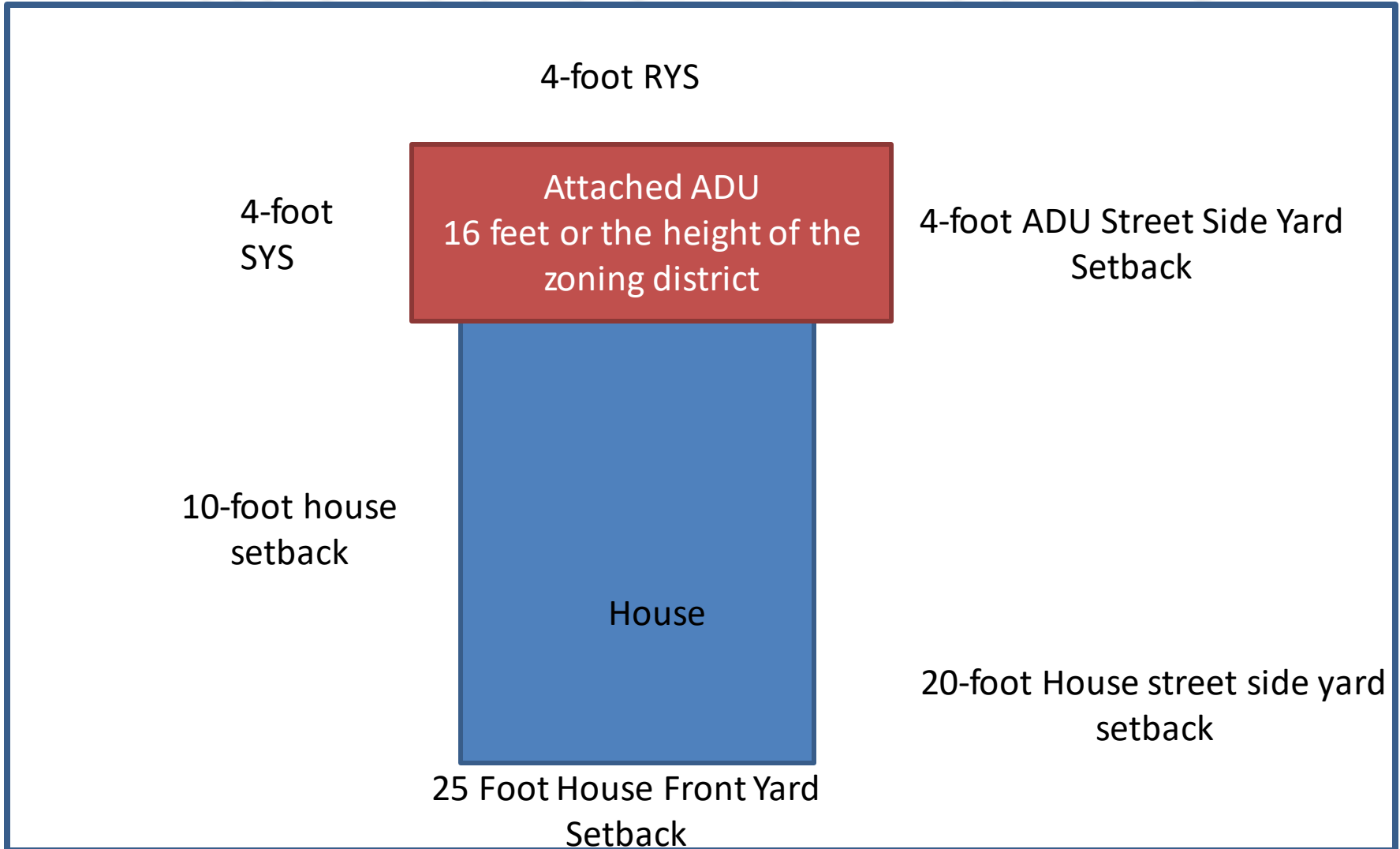

Attached ADU-Garage Conversion

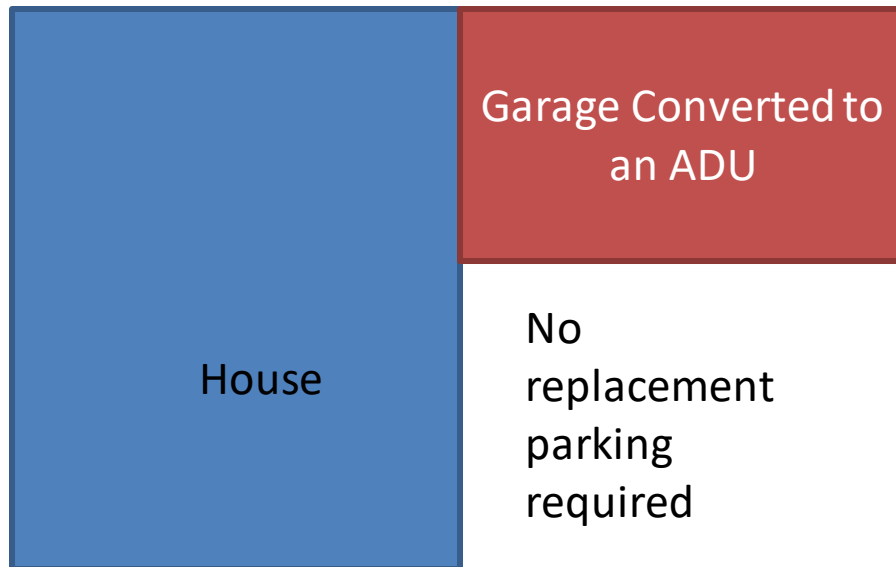

Proposed Los Altos Detached ADU Standards

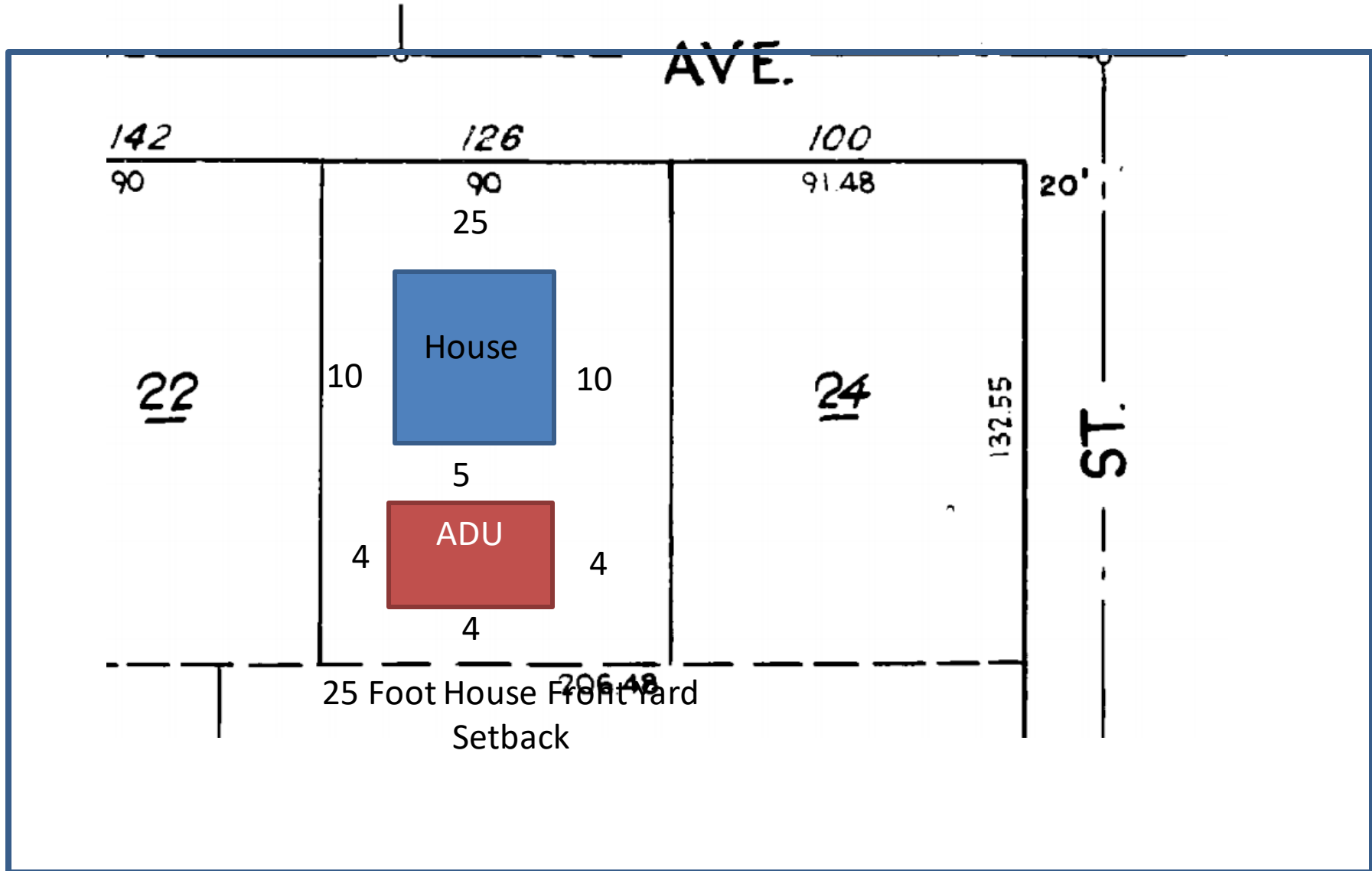

Detached ADU

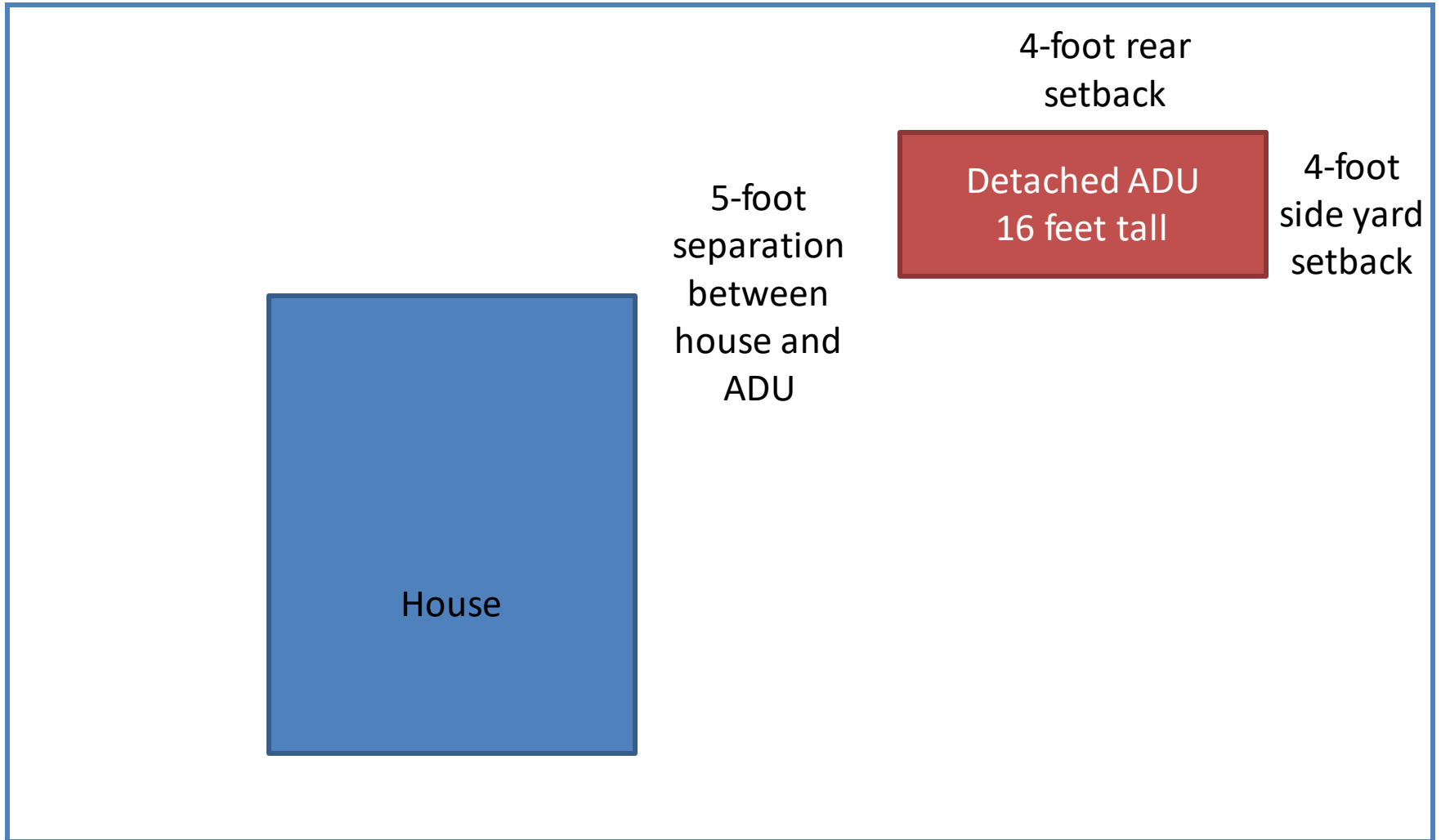

Junior ADUs + Detached ADUs

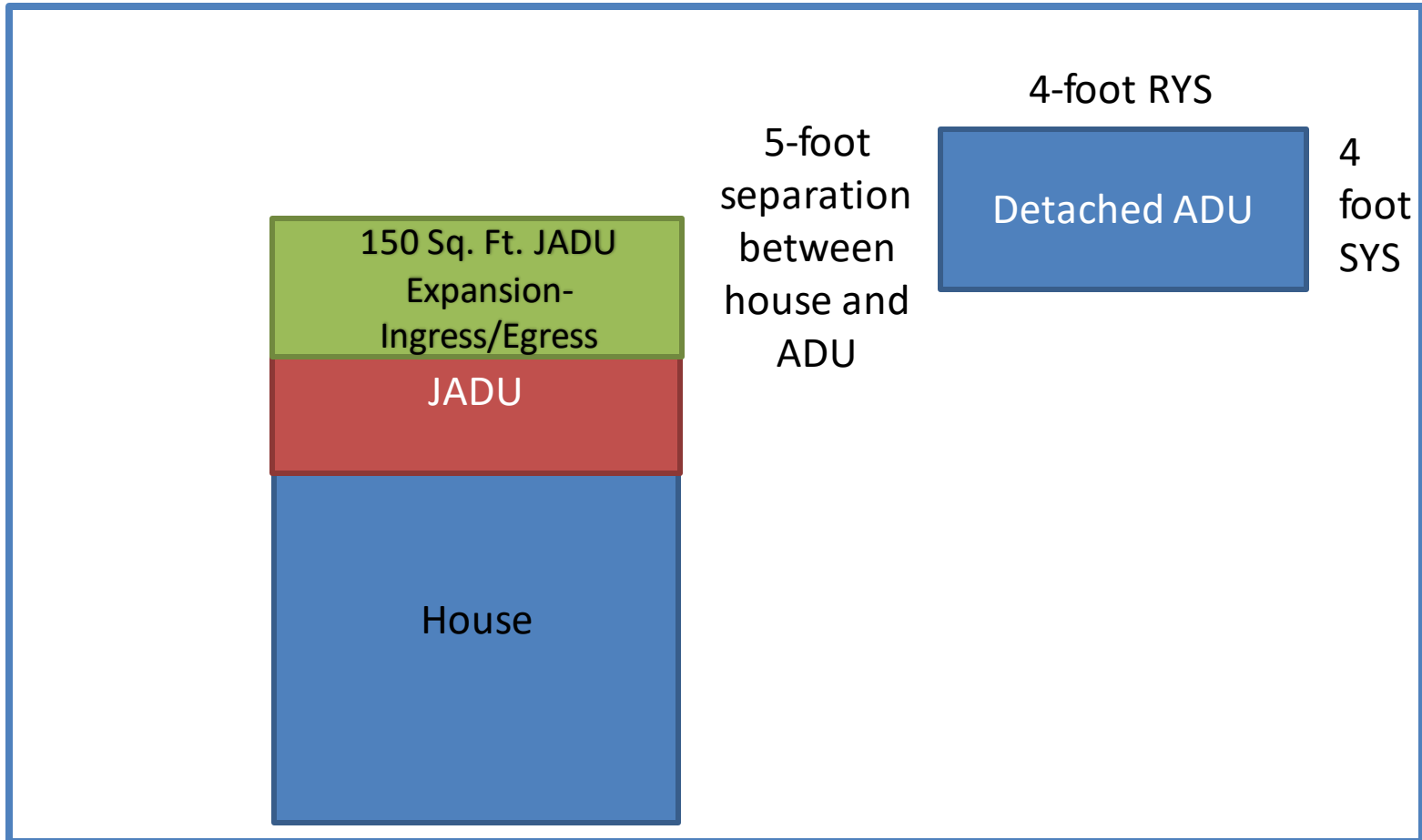

JADUs and remodel/addition-Policy Choice for Council

Allowing JADUs with additions	Limiting JADUs to existing space and only allowing an addition of 150 sq. ft per State law for ingress/egress
Daly City	Sunnyvale
Milpitas	Alameda
Fremont	Saratoga
Los Altos Hills	

Multi Family and ADUs

Detached ADU

Detached ADU

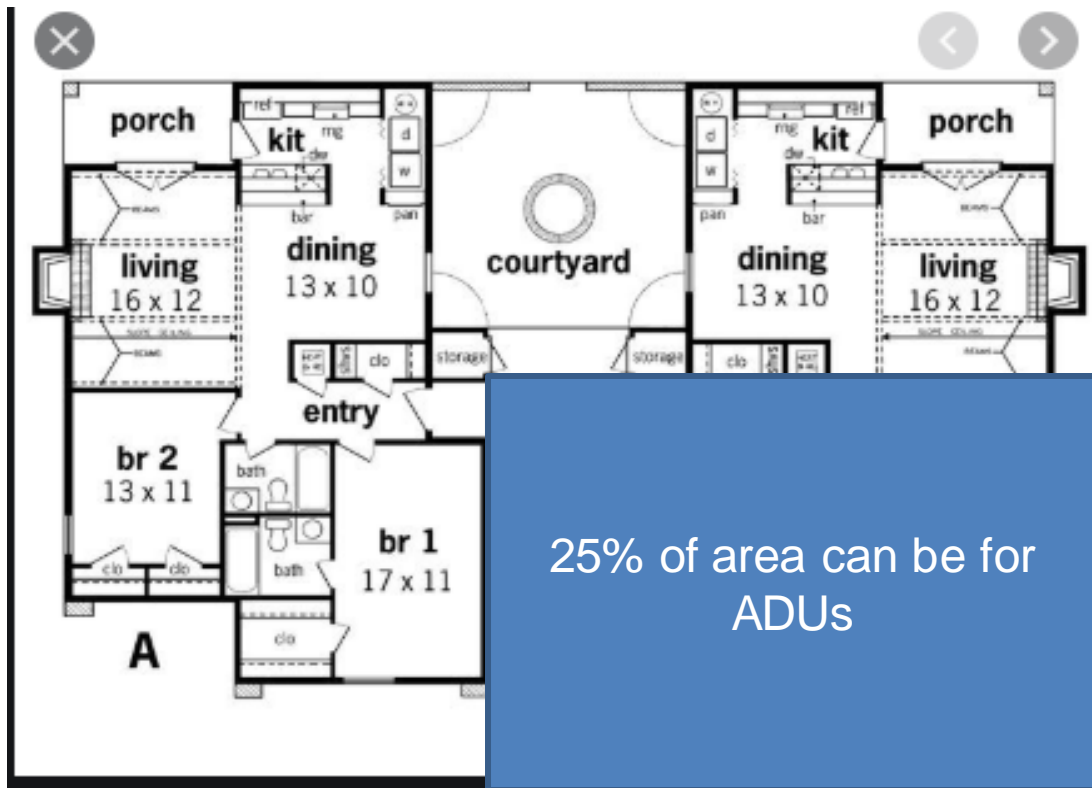

Accessory Structures

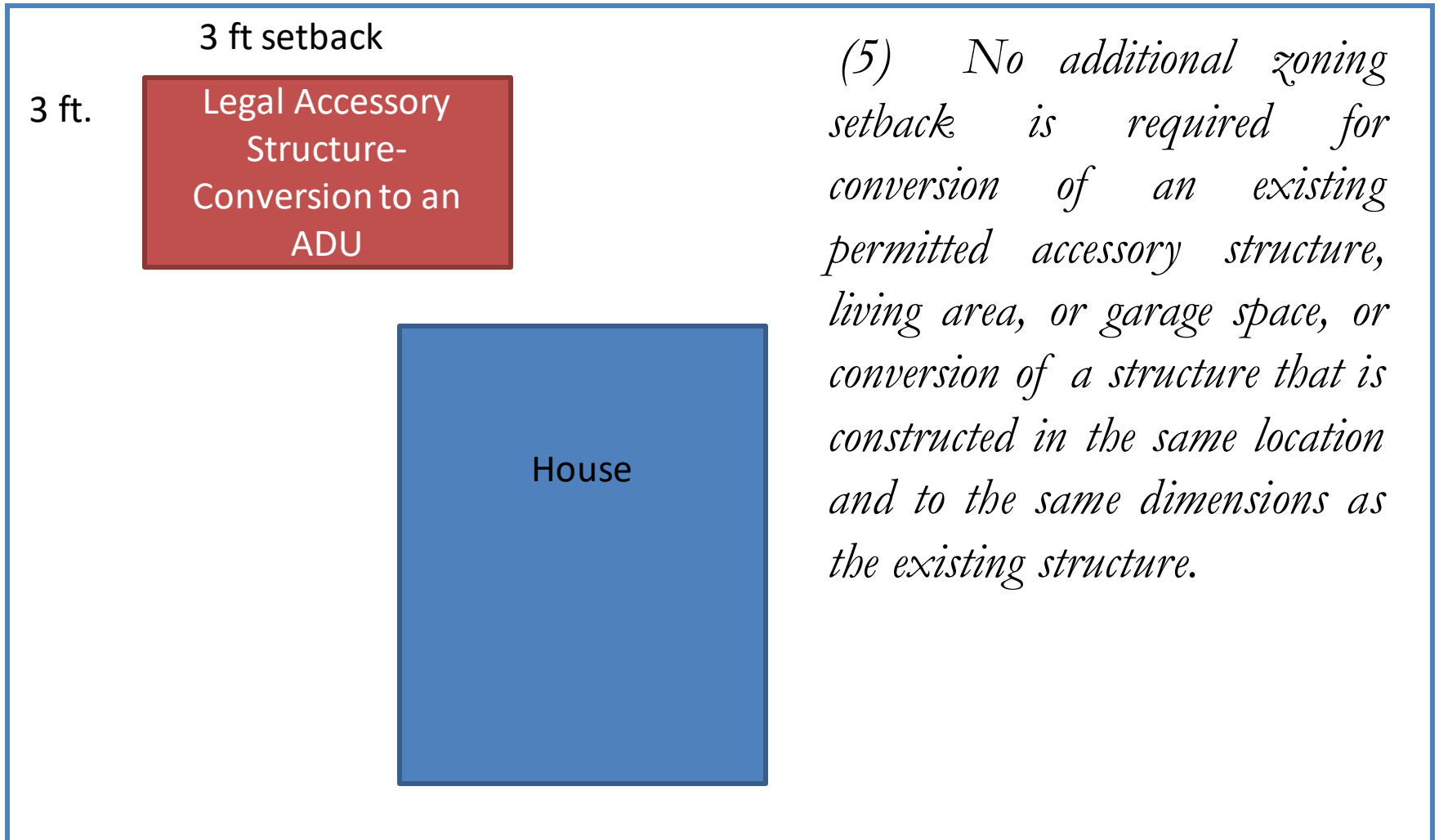

```
graph LR; A[General Overview] --> B[Specific Examples-New and Old Regulations]; B --> C[State HCD Edits];
```

General
Overview

Specific
Examples-New
and Old
Regulations

State HCD Edits

State HCD Edits

Four Feet Setback

Verbiage was added to make it clear that either attached or detached ADU must be no more than four (4) feet from the side or rear property lines.

A single-family residential accessory dwelling unit either attached or detached from the main house must not encroach upon the required front lot line area or four feet from the side yard property line.

State HCD-Parking Nonconformance

An existing garage, carport or parking structure is converted or demolished to accommodate a single-family residential accessory dwelling unit in the same location. ~~If the required parking for the main single-family residence is removed the property owner must submit a notarized letter to the City acknowledging removal of said parking could create a nonconformity for future expansions of the single-family dwelling.~~

State HCD Edits

Multi Family Housing and ADUs

The type of ADUs described in the single-family portion of the ordinance may also be built on a multifamily site if so desired.

State HCD Edits

Multi-Family Housing and Other Regulatory Conflicts

An owner may also construct up to a maximum of two detached accessory dwelling units on a lot that has an existing multifamily dwelling, subject to a height limit of sixteen (16) feet and four (4) foot rear yard and side setbacks. If there are inconsistencies between this Chapter and other provisions of the Los Altos municipal code, this Chapter shall prevail over those other provisions.

State HCD Edits-Multi Family Housing Amenities

Portions of existing multi-family dwelling structures that are not used as livable space (including, but not limited to, storage rooms, boiler rooms, passageways, attics, basements, or garages), but excluding any residential amenities required to be provided for the facility by the zoning ordinance, or as a condition of project approval, may be converted for use as accessory dwelling units provided that total number of units must not exceed twenty-five (25) percent of the existing multi-family dwelling units or one (1) unit, whichever is greater.

```
graph LR; A[General Overview] --> B[Specific Examples-New and Old Regulations]; B --> C[Commission Edits];
```

General
Overview

Specific
Examples-New
and Old
Regulations

Commission
Edits

14.14.021-Category of ADUs

This chart was added to the ordinance. Should not be taken to cover all of the nuisances of six bills that made significant changes to state law, but just as a general guide post for applicants.

Square Footage Chart

Design Standards	Junior ADU	Attached ADU (single-family)	Detached ADU (single-family)
Maximum Size (see 14.14.025 for additional details)	500 sq. ft. created from the <u>existing or proposed</u> square footage of the residential structure.	1,200 sq. ft. but no more than 50% of the floor area of an existing or proposed primary dwelling unit (<u>excluding</u> basement area).	1,200 sq. ft. <u>including</u> basement area).
Maximum Height	NA	The greater of 16 feet or the height of the underlying zoning district	16 feet
Side Setback	NA	4 feet (see exception identified within 14.14.050(f)(5))	4 feet
Rear Setback	NA	4 feet (see exception identified within 14.14.050(f)(5))	4 feet
Kitchen	Cooking appliances can include hot plate, or counter-top cooking. A wall installed oven is not required.	Must include at least a sink, a refrigerator of no less than 10 cubic feet, and either a cooktop and an oven, or a range. A food preparation counter and storage cabinets that are of reasonable size in relation to the size of the ADU are also required.	
Parking Requirement	None	1 uncovered parking space required. See Section 14.14.050(i)(1-6) for the exceptions to this requirement	
Owner Occupancy	Required	Not required	
Short Term Rentals	Prohibited	Prohibited	
Impact Fees	None	750 sq. ft. or less-no impact fees 751 sq. ft or more-impact fees are proportionate to principal dwelling	

Detached ADUs

(2) A **detached** single-family residential accessory dwelling unit shall not exceed eight hundred fifty (850) square feet in floor area, or one thousand (1,200) square feet for a detached accessory dwelling unit with more than one (1) bedroom. Additional square footage above 850 square feet shall be allowed only if the lot meets the lot coverage and floor area ratio requirements for the applicable zoning district. For detached accessory dwelling units, garage area is excluded but basement areas **are included** in the square footage calculation.

Attached ADUs-50% Rule

(3) *The total floor area for an **attached** accessory dwelling unit shall not exceed one thousand two hundred (1,200) square feet, **excluding** the basement areas, and shall not be more than fifty (50) percent of the floor area of the existing or proposed principal residence. Notwithstanding this 50% threshold requirement, an attached ADU of 850 square feet or smaller cannot be denied. Additional square footage above 850 square feet shall be allowed only if the lot meets the lot coverage and area ratio requirements for the applicable zoning district.*

Internal Conversion-Policy Question for Council

A new detached accessory dwelling unit and an addition to the primary dwelling are limited to 1,200 square feet.

There is no size limitation on an accessory dwelling unit that is created by converting space within the existing primary dwelling or accessory structure. If a homeowner converts a portion of the primary dwelling for an attached accessory dwelling unit, nothing herein shall prevent the homeowner from replacing the square footage lost, subject to the applicable design rules for the specific zoning district.

Four Foot Setback-Maximum

(1) A single-family residential accessory dwelling unit either attached or detached from the main house must not encroach upon the required front lot line area or four feet from the side yard property line. Four feet setbacks is the maximum the City can recommend per state law, but applicants are encouraged to voluntarily comply with the setbacks identified within 14.14.080 of ten feet from the side and rear property lines so as to reduce privacy impacts.

Los Altos Current Daylight Plane Diagram

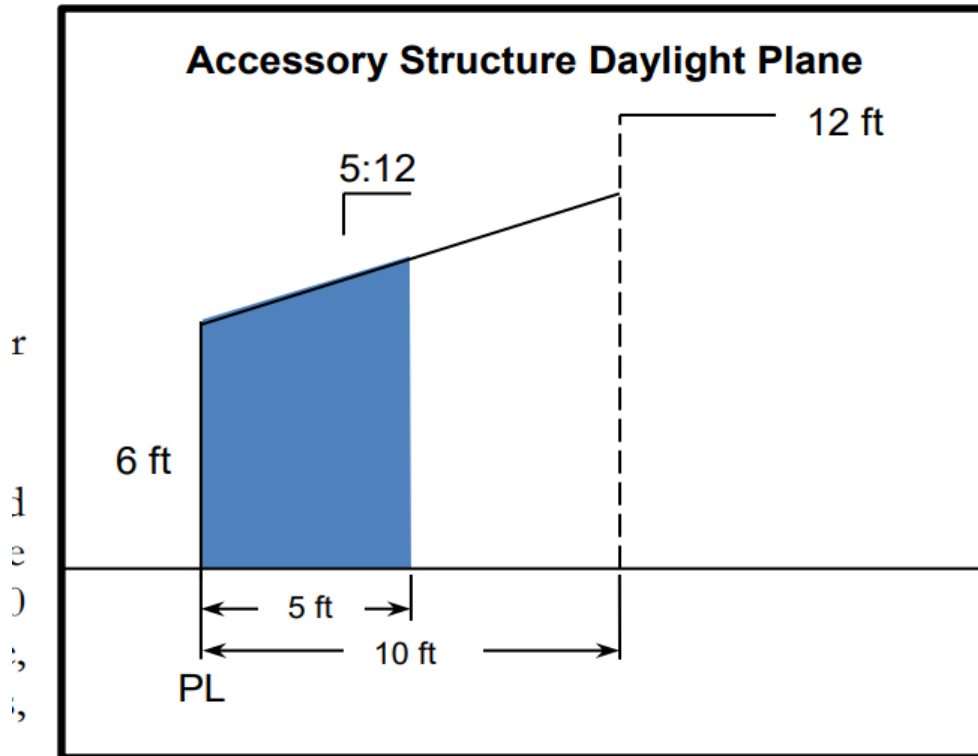

require a separation of at least 10 feet from the main house

Daylight Plane Options

8-Foot, 5/12 Pitch Daylight Plane

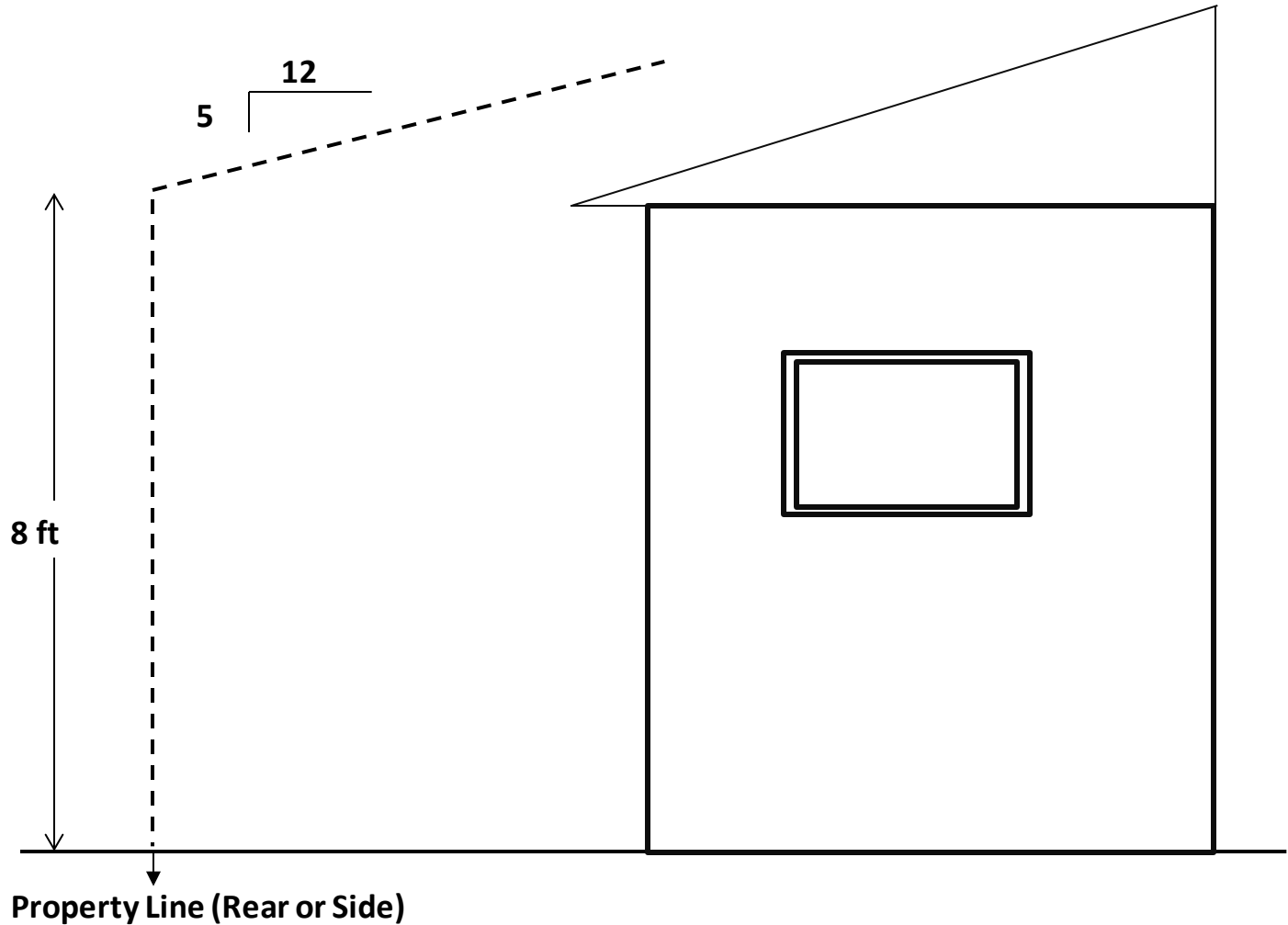

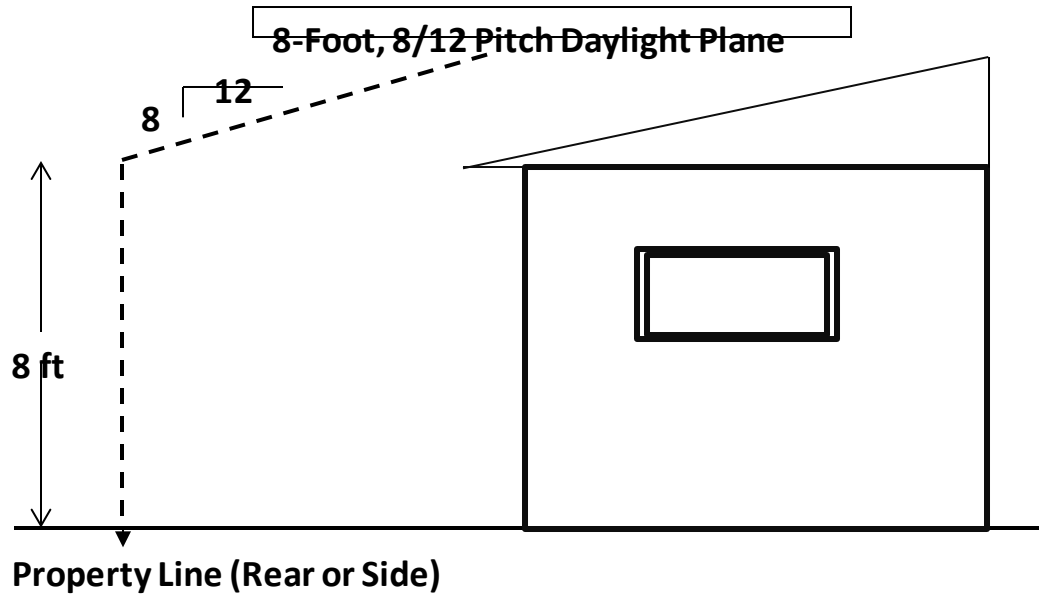

7-Foot, 5/12 Pitch Daylight Plane

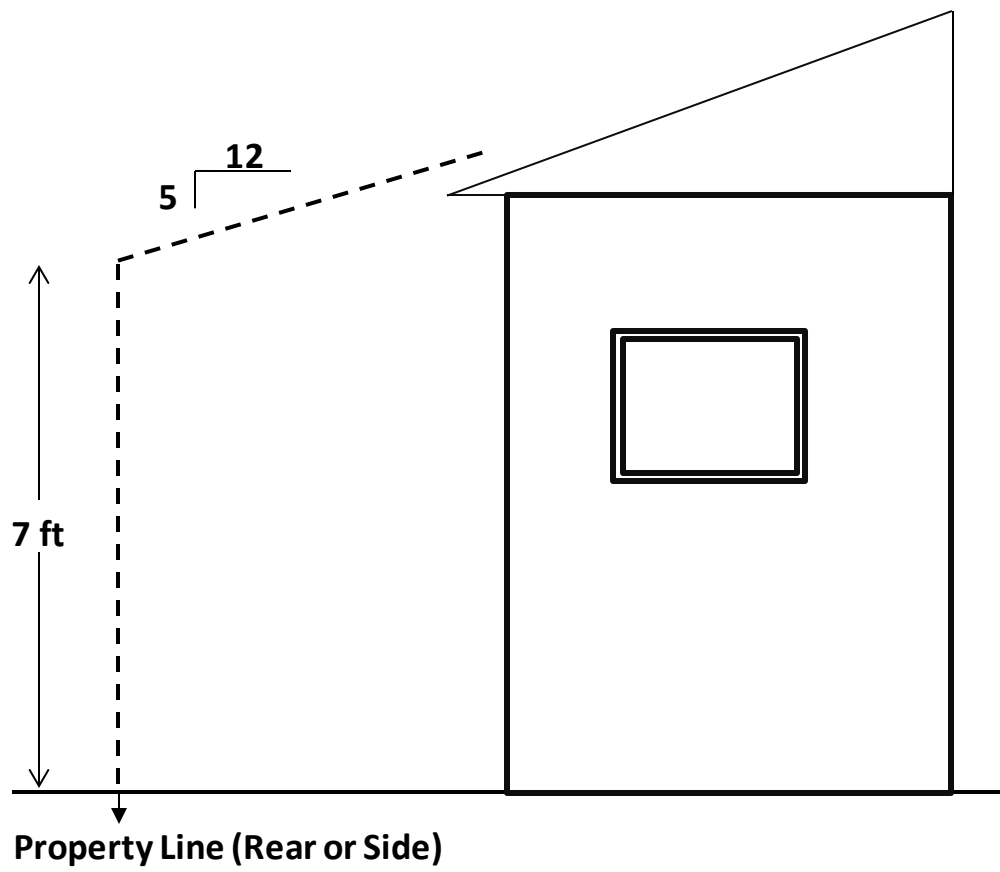

7-Foot, 6/12 Pitch Daylight Plane

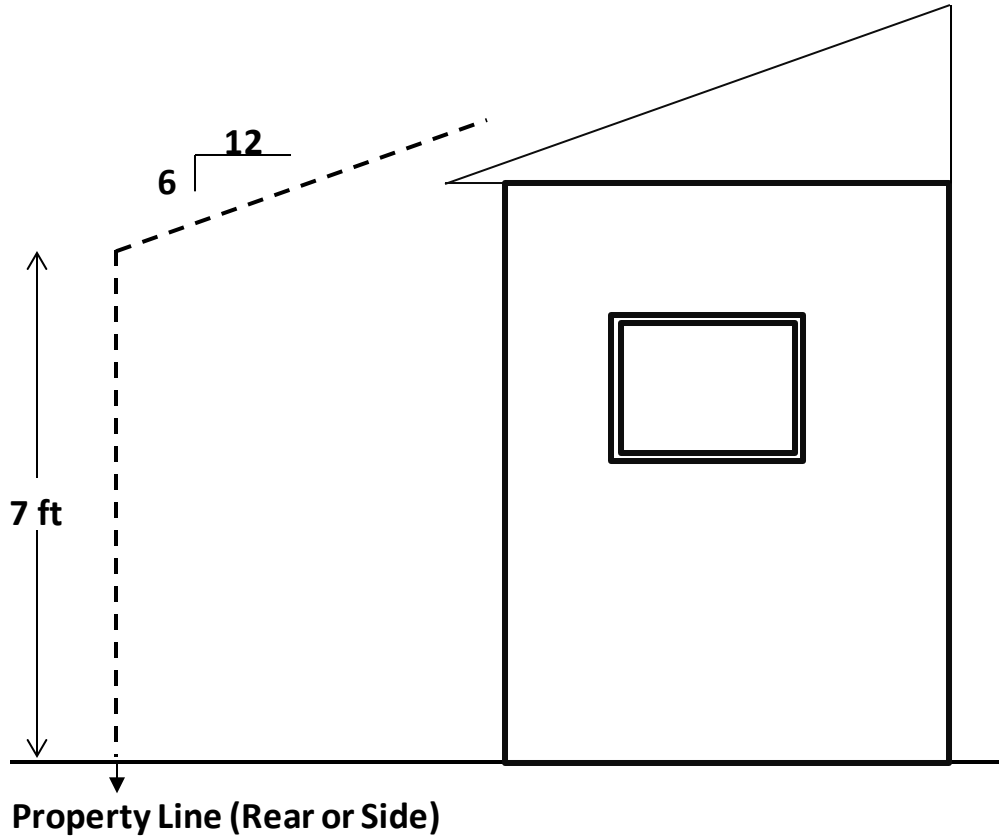

7-Foot, 12/12 Pitch Daylight Plane

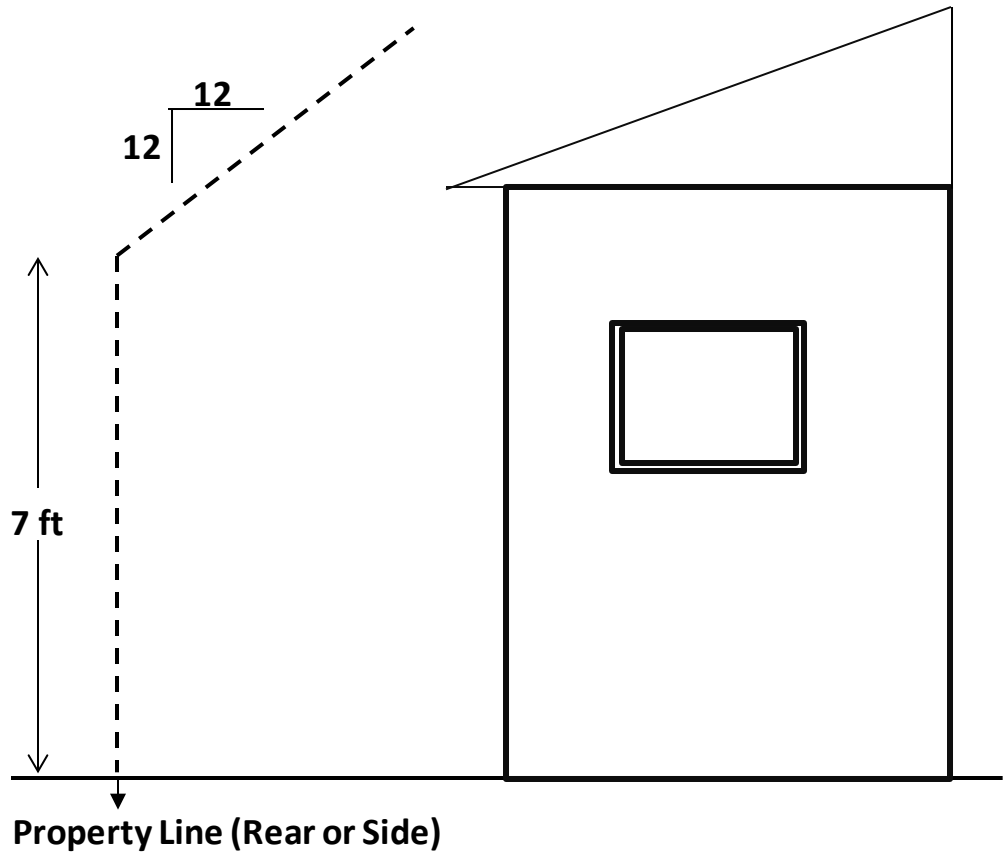

7-Foot, 8/12 Pitch Daylight Plane

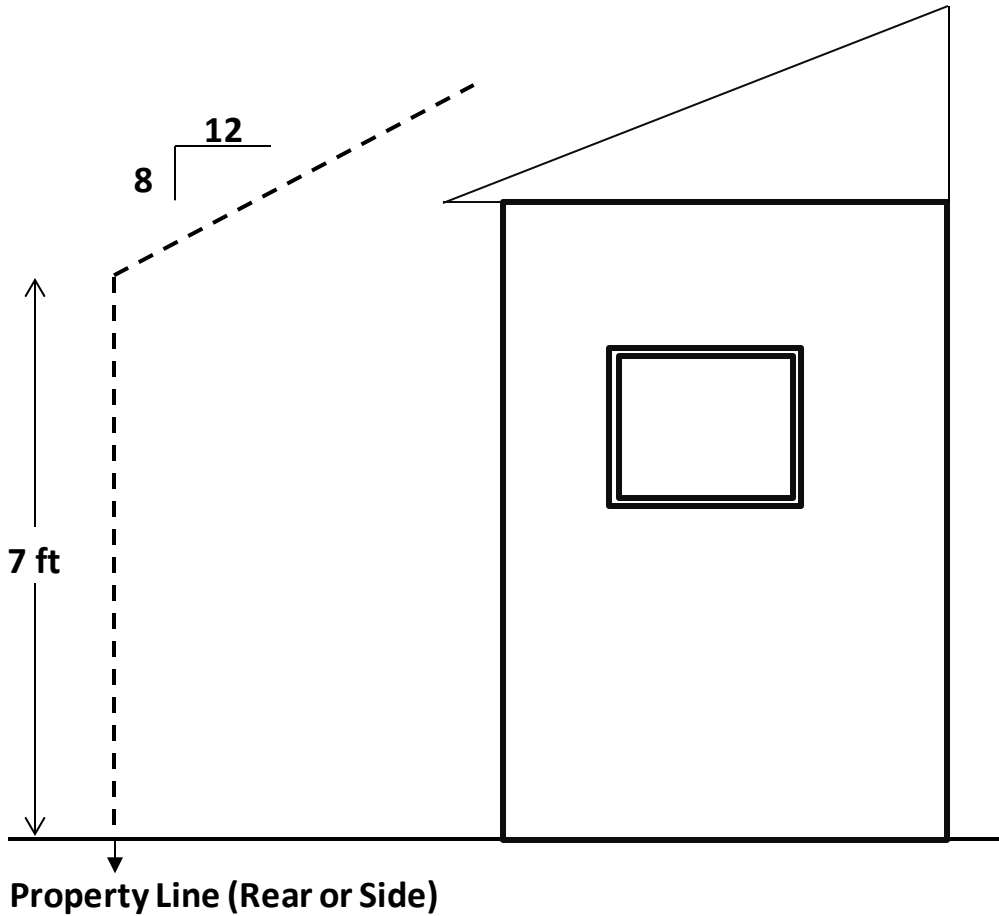

Planning Commission Recommendation-Daylight Plane-

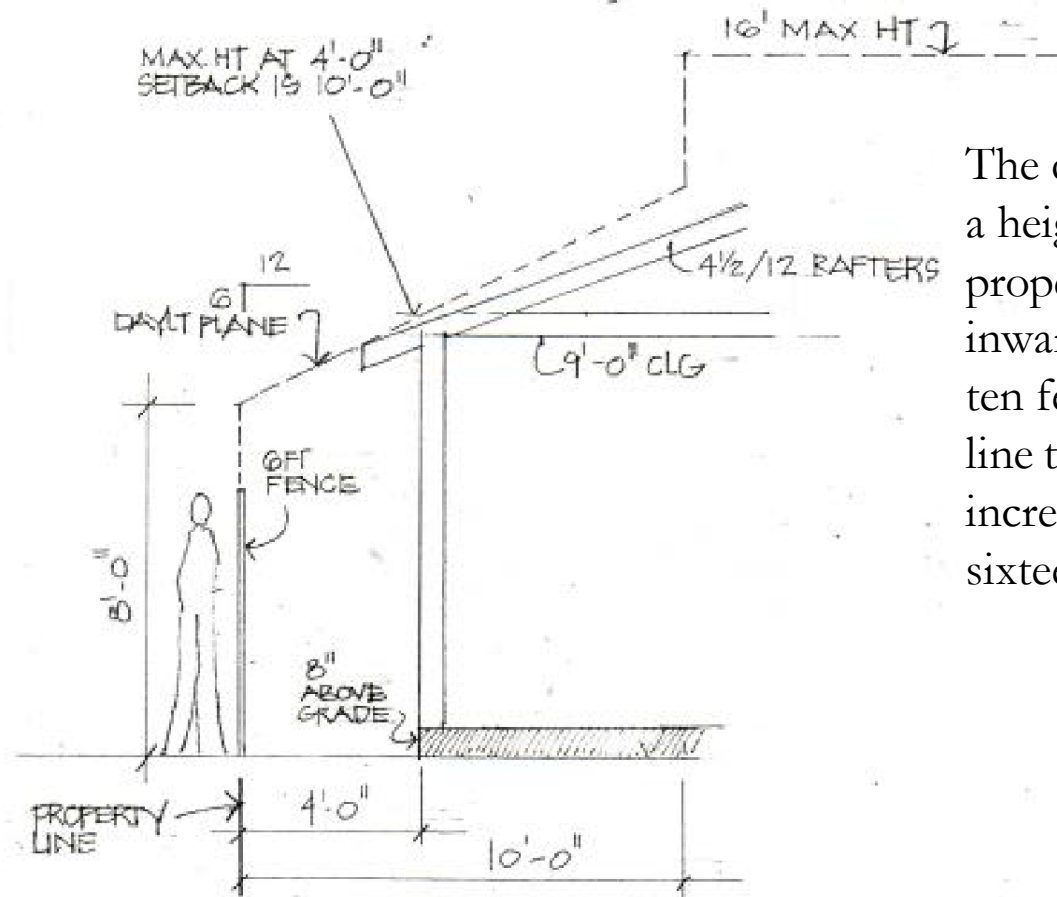

The daylight plane starts at a height of eight feet at the property line and proceeds inward at a 6:12 slope. At ten feet from the property line the structure can increase in height to sixteen (16) feet.

Fees

- Reduction of permit fees might be a positive step to show residents and State HCD that Los Altos wants to incentive these units.
- This would also be in accordance with AB 671.

RHNA and ADUs

Los Altos should begin a process of collecting ADU rental data to support meeting our long term RHNA goals.

Hillsborough ADU Survey

TOWN OF HILLSBOROUGH
California

ACCESSORY DWELLING UNIT (ADU) SURVEY

The Town of Hillsborough adopted an ordinance amending the municipal code regarding accessory dwelling units (ADUs) to comply with State law that became effective on January 14, 2019.

While Hillsborough is a single family residential community, ADUs provide an affordable housing opportunity without altering the unique character of the Town.

The Town's Housing Element commits the Town to gathering information and rental rates (as applicable). The information you provide in this survey is intended to reflect your initial planned use of the ADU and will not restrict how you may use it in the future.

The completed survey form shall be submitted to the Planning Department prior to submittal of a building permit. Please answer the following questions:

Address: _____

Is your second unit intended to be used for:

- Family member _____
- Rental _____
- Domestic help _____
- Short stay guest _____
- Other _____

How many bedrooms are in your second unit? _____

How many people do you expect to occupy your second unit? _____

If your second unit is intended for rent, please check what range of monthly rent you intend to initially charge for the accessory dwelling unit:

- \$0 to \$888 \$889 to \$1,481 \$1,482 to \$1904 \$1905- 2962 \$2,963+

Code Enforcement Deferral-(SB 13)

17980.12.

(a) (1) An enforcement agency, until January 1, 2030, that issues to an owner of an accessory dwelling unit described in subparagraph (A) or (B) below, a notice to correct a violation of any provision of any building standard pursuant to this part shall include in that notice a statement that the owner of the unit has a right to request a delay in enforcement pursuant to this subdivision:

(A) The accessory dwelling unit was built before January 1, 2020.

(2) The owner of an accessory dwelling unit that receives a notice to correct violations or abate nuisances as described in paragraph (1) may, in the form and manner prescribed by the enforcement agency, submit an application to the enforcement agency requesting that enforcement of the violation be delayed for five years on the basis that correcting the violation is not necessary to protect health and safety.

(3) The enforcement agency shall grant an application described in paragraph (2) if the enforcement determines that correcting the violation is not necessary to protect health and safety. In making this determination, the enforcement agency shall consult with the entity responsible for enforcement of building standards and other regulations of the State Fire Marshal pursuant to Section 13146.

After Packet Production

17 letters of support

Commissioner Bressack's email

Bressick's Email/Staff Response-1

Bressick's Edits	Staff Response`
<p>So the actual ordinance wording in 14.14.050 (f)(1) needs to include intentional wording ie:</p> <p>"...Four feet setbacks <i>at rear and side yards is the minimum</i> per state law, but applicants are encouraged to voluntarily comply with the setbacks identified within 14.14.080 of ten feet from the side and rear property lines so as to reduce privacy impacts <i>and in doing so be removed from daylight plane restrictions.</i>"</p>	<p>These edits are acceptable.</p>

Bressick's Email/Staff Response-2

Bressick's Comments	Staff Response
<p>For a detached accessory dwelling unit, the minimum setbacks shall be five feet (5) from the house and four feet (4) from the side yard and rear yard property lines. However, so as to reduce the privacy impacts to abutting property owners, applicants are encouraged to voluntarily increase the setbacks to be ten feet (10) from the rear yard property line and ten feet (10) from the interior side yard property lines. If the applicant provides the ten (10) foot rear yard and interior side yard setbacks the daylight plane provisions will not be enforced..."</p>	<p>These edits are acceptable</p>

Bressick's Email/Staff Response-3

Bressick's Email	Staff Response
<p>To that end 14.050.(d)(4) could read:</p> <p>"...If a homeowner converts a portion of the primary dwelling for an attached accessory dwelling unit, the homeowner may replace the square footage lost, up to 850sf above FAR limits, subject to the design rules for the specific zoning district.</p> <p>"</p>	<p>I think the ordinance, as written is actually more clear that building back the square footage is only acceptable if it meets the zoning requirements. As written the proposal would seem to imply you can build back up to 850 above the FAR for the district.</p> <p><i>Draft Language</i></p> <p><i>A new detached accessory dwelling unit and an addition to the primary dwelling are limited to 1,200 square feet. There is no size limitation on an accessory dwelling unit that is created by converting space within the existing primary dwelling or accessory structure. If a homeowner converts a portion of the primary dwelling for an attached accessory dwelling unit, nothing herein shall prevent the homeowner from replacing the square footage lost, <u>subject to the applicable design rules for the specific zoning district.</u></i></p>

Recommendation

- 1- The Planning Commission and staff recommend that the City Council introduce and waive further reading of the proposed ordinance
- 2- Adopt Zoning Text Amendment 20-0001 and further find the project is exempt from CEQA per Section 21080.17 of the Public Resources Code.
- 3-Amend the Master Fee Schedule to reduce the ADU permit fees for accessory dwelling units for a period of twelve (12) months after final adoption by the City Council of the ordinance.
- 4-Direct staff to prepare an annual ADU rental income survey to be released no later than September 1st of every calendar year. To collect said data and to report this information to State HCD for purposes of meeting the City's RHNA Housing Element figures.

Questions/Comments



Amazon.com: Etch A Sketch - Classi...

Ar

2019 Los Altos ADU Approvals

24 Approved in
2019

16716010	132 LOUCKS AVE	ADU19-0009	ADU
16727026	491 PATRICK WY	2019-1108659	ADU
16732045	324 CHERRY AVE	ADU19-0014	ADU
16732048	181 SYLVIAN WAY	ADU19-0037	ADU
16734008	356 BLUE OAK LN	ADU19-0018	ADU
16735072	20 LOS ALTOS AV	2018-1108461	ADU
17020005	659 SPARGUR DR	ADU19-0017	ADU
17021050	215 VERANO DR	ADU19-0024	ADU
17037010	200 LYELL ST	ADU19-0008	ADU
17040016	49 LYELL ST	ADU19-0026	ADU
17511047	13 CYPRESS CT	ADU19-0004	ADU
17515014	581 W UNIVERSITY AV	2018-1108437	ADU
18920005	950 SEENA AVE	ADU19-0028	ADU
18929094	821 ARROYO RD	ADU19-0015	ADU
18936042	689 RIVIERA DR	ADU19-0021	ADU
18936068	601 HAWTHORNE AVE	DR19-0112	ADU
18938043	656 BENVENUE AVE	ADU19-0027	ADU
19327014	934 O'DELL WAY	ADU19-0019	ADU
19335030	1251 PETERSEN CT	2018-1108410	ADU
19703052	1456 FALLEN LEAF LN	ADU19-0025	ADU
19703053	1464 FALLEN LEAF LN	ADU19-0005	ADU
19716056	1544 MARLBAROUGH	DR19-0142	ADU
19718015	1345 RANCHITA DR	DR19-0011	ADU
34203047	538 SEQUOIA DR	ADU19-0012	ADU