

June 28, 2011



Collector Traffic Calming Plan

RBF
CONSULTING





This Page Intentionally Left Blank



Table of Contents

Executive Summary	1
1.0 Introduction	6
2.0 Existing Collector Traffic Conditions	9
2.1 Travel Speeds	9
2.2 Volumes	10
2.3 Accidents	14
2.4 Prioritized Intersections	14
3.0 A Traffic Calming Toolkit for Los Altos Collector Streets	15
3.1 Bulbouts	17
3.2 Chokers	19
3.3 Raised Crosswalks	21
3.4 Roundabouts	23
3.5 Mini-Roundabouts	27
3.6 Medians	29
3.7 Meandering Roadways	31
3.8 Raised Intersections	33
3.9 Speed Table	35
3.10 Surface Treatments and Mounds	36
3.11 Treated Bike Lanes	37



4.0	The Collector Traffic Calming Plan	38
4.1	Plan Development.....	38
4.2	Plan Summary	40
4.3	Almond Avenue: San Antonio Road to El Monte Avenue	45
4.4	Covington Road: Grant Road to Springer Road	47
4.5	Covington Road: Springer Road to El Monte Avenue	49
4.6	Cuesta Drive: Springer Road to El Monte Avenue	51
4.7	Cuesta Drive: El Monte Avenue to San Antonio Road	53
4.8	West Edith Avenue: Foothill Expressway to San Antonio Road	55
4.9	El Monte Avenue: Foothill Expressway to Springer Road	57
4.10	Fremont Avenue: Springer Road to Miramonte Avenue	59
4.11	Fremont Avenue: Miramonte Avenue to Grant Road	61
4.12	Fremont Avenue: Grant Road to Eastern City Boundary (Stevens Creek)	63
4.13	Grant Road: Foothill Expressway to Fremont Avenue	65
4.14	Grant Road: Fremont Avenue to Covington Road	67
4.15	Los Altos Avenue: West Edith Avenue to Pine Lane	69
4.16	Los Altos Avenue: Pine Lane to City Boundary (El Camino Real)	71
4.17	Main Street: Foothill Expressway to San Antonio Road.....	73
4.18	Miramonte Avenue: Fremont Avenue to City Boundary (Alegre Avenue).....	75
4.19	Springer Road: Foothill Expressway to Cuesta Drive	77
4.20	Springer Road: Cuesta Drive to City Boundary (Hollingsworth Drive)	79
4.21	St. Joseph Avenue: Foothill Expressway to St. Mathew	81
4.22	Traffic Calming Plan Element Costs	83
4.23	Process of Ranking the Collector Streets	87



5.0 Traffic Diversion 88

5.1 Candidate Diversion Routes 88

5.2 Monitoring and Preventing Re-Routing..... 89

6.0 Traffic Calming Concept Design: Fremont Avenue Corridor 90

6.1 Overview..... 90

6.2 Traffic Operations 90

6.3 Stevens Creek Trail Study..... 92

6.4 Cost Estimates and Phasing 92

7.0 Impacts to Emergency Vehicles (FIRE) 94

7.1 Fire Station Locations 94

7.2 Delay to Fire Vehicles by Type of Device 96

7.3 Impacts to Fire Vehicles from Proposed Traffic Calming Plan 97



List of Figures

Figure 1 Existing Conditions Map.....	12
Figure 2 Collector Traffic Calming Plan Map.....	42
Figure 3 Map of Fire Stations in Los Altos	95

List of Tables

Table 1.1 Traffic Calming Measure Benefits.....	8
Table 4.1 Estimated Speed Reduction Results	41
Table 4.2 Estimated Costs of Traffic Calming Devices	83
Table 4.3 Corridor Ranking	87
Table 6.1 Fremont Avenue Intersection LOS.....	91
Table 6.2 Fremont Avenue Opinion of Probable Costs	93
Table 7.1 Fire Response Times	98

Appendices

Appendix A. Fremont Avenue Concept Design.....	99
Appendix B. Priority Intersections.....	121
Appendix C. Intersection Level of Service Calculations.....	123



This Page Intentionally Left Blank



Executive Summary

The City of Los Altos Collector Traffic Calming Plan is compiled to develop a strategy to reduce 85th percentile speeds on the collectors to allow enforcement of the current posted speed limits which range between 25 and 30 miles per hour. The Collector Traffic Calming Plan is a framework for implementation of traffic calming devices on collector roadways in the City of Los Altos and does not identify design level improvements; however, it does identify specific devices and approximate spacing of devices necessary to achieve speed reductions along the collectors. Actual placement and detailed design of devices will be determined during future engineering design phases in the implementation of the Plan.

This Collector Traffic Calming Plan identifies a prioritized list of recommended projects based on a rating system that considers pertinent data including volume, speed and cost. The projects identified in this Plan are conceptual in nature and will be evaluated in detail during the design phase as the projects are implemented. When future projects are scheduled for implementation, staff will present to Council the scope and limits of the proposed project before advertising a consultant Request for Proposal (RFP) for design services. Furthermore, all future projects will be presented at a public meeting during the preliminary design stage and questions and comments can be addressed.

In preparation of this Plan, the City coordinated efforts with other concurrent studies such as the Bicycle Transportation Plan, Loyola Corners Project and the Blach School Neighborhood Traffic Study. Public comments received from a public workshop, Traffic Commission meetings, and Council workshops have been evaluated and incorporated into this Plan. Input was also received from the City of Mountain View and Santa Clara County Fire Department.

A more detailed traffic calming concept design is developed in this Plan for Fremont Avenue between Springer Road and the City limits to the east. The intent was that a portion of the concept design would be used for the FY2009-2010 Capital Improvement Program (CIP), Collector Street Traffic Calming, Project 10-12, which included incorporating traffic calming on a portion of Fremont Avenue using the City's Traffic Impact Fees.



The following traffic calming measures are included in the City-adopted Traffic Calming Toolkit for use on collector streets and were utilized in the development of the Plan:

- Bulbouts
- Chokers (only recommended on local (residential) streets in the Toolkit)
- Raised crosswalks
- Roundabouts
- Mini-Roundabouts (only recommended on local (residential) streets in the Toolkit)
- Medians

The City Toolkit includes traffic calming measures available for use on the streets in Los Altos. Although the Toolkit only shows chokers and mini-roundabouts for the residential streets, the collector streets in the City are similar in nature to residential streets, therefore these two devices are being recommended in this Plan for many of the collectors. The Toolkit includes the use of speed humps on local streets. This Plan does not recommend using these measures on collector streets, since they may create traffic diversion onto local streets.

In addition, the following measures are also recommended for implementation on the collectors in this Plan because they are traffic calming tools used in the industry that would calm traffic and improve safety at intersections and on streets:

- Meandering roadways (similar to Chicanes which are mentioned in the Toolkit, but recommended for local streets)
- Raised intersections
- Speed tables
- Surface treatment / mounds
- Treated bike lanes



For the selection of the devices, consideration was given to the existing geometry of the roadway, line of sight, sidewalks and bicycle lanes, on-street parking and right-of-way. The final selection of the traffic calming measures and their design and placement, will require input from the public at community workshops, City staff and emergency service personnel. The following collectors were studied in the Plan.

- Almond Avenue between San Antonio Road and El Monte Avenue
- Covington Road between El Monte Avenue and Grant Road
- Cuesta Drive between San Antonio Road and Springer Road
- El Monte Avenue between Foothill Expressway and Springer Road
- Fremont Avenue between City Boundary (Stevens Creek) and Springer Road
- Grant Road between Foothill Expressway and City Boundary (Covington Road)
- Los Altos Avenue between West Edith Avenue and City Boundary (El Camino Real)
- Main Street between Foothill Expressway and San Antonio Road
- Miramonte Avenue between Fremont Avenue and City Boundary (Alegre Avenue)
- Springer Road between Foothill Expressway and City Boundary (Hollingsworth Drive)
- St. Joseph Avenue between Foothill Expressway and St. Mathew Way
- West Edith Avenue between Foothill Expressway and San Antonio Road

Results from recent speed studies reveal that current 85th percentile traffic speeds are between 7 and 14 miles per hour over the posted speed limits along all the City of Los Altos collector streets included in this study. The reduction in speeds on the studied collectors, with implementation of the recommended measures in this Plan, would be expected to be between 5% and 20%.

It should be noted that a 10% reduction in speed with the implementation of traffic calming measures will result in a 20% reduction in required stopping distance, which will enhance driver safety by possibly reducing the severity and number of traffic accidents.



The Plan indicates that an enforcement goal of 25 MPH on certain corridors cannot be achieved on all the collectors due to the fact that implementing too severe measures may result in collector traffic diverting onto local streets. The following table summarizes the potential implementation findings of each corridor:

Street Name	2007 Traffic 85% Speed	Current Posted Speed Limit	Typical Reduction in Speed Based on Proposed TC Measures	Speed Reduction	Estimated Reduced Speed	Enforceable Speed Limit with Traffic Calming	Enforceable Speed Limit Without Traffic Calming
Fremont Avenue	37 - 39 MPH	30 MPH	5 - 20%	7 - 8 MPH	30 - 31 MPH	30 MPH	35 - 40 MPH
Springer Road	39 MPH	30 MPH	5 - 20%	8 MPH	31 MPH	30 MPH	40 MPH
Grant Road	38 MPH	25 MPH	5 - 20%	9 MPH	29 MPH	30 MPH	40 MPH
Miramonte Avenue	36 MPH	25 MPH	5 - 10%	4 MPH	32 MPH	30 MPH	35 MPH
Cuesta Drive	35 MPH	25 MPH	5 - 10%	6 MPH	29 MPH	30 MPH	35 MPH
Covington Road	32 - 35 MPH	25 MPH	5 - 10%	3 MPH	29 - 32 MPH	30 MPH	35 MPH
West Edith Avenue	34 MPH	25 MPH	5 - 10%	5 MPH	29 MPH	30 MPH	35 MPH
El Monte Avenue	33 MPH	25 MPH	5 - 20%	7 MPH	26 MPH	25 MPH	35 MPH
Almond Avenue	32 MPH	25 MPH	10%	3 MPH	29 MPH	30 MPH	30 MPH
Los Altos Avenue	32 MPH	25 MPH	5 - 10%	3 MPH	29 MPH	30 MPH	30 MPH
St. Joseph Avenue	No Speed Survey Data	25 MPH	5 - 10%	3 MPH	NA	NA	NA
Main Street	No Speed Survey Data	25 MPH	5 %	1 MPH	NA	NA	NA

Note:

Yellow highlighted rows will achieve the goal.

Pink highlighted rows are streets that will remain at 30 MPH with or without traffic calming measures.

Green highlighted rows are streets where achievement depends on the traffic survey speed.

The table indicates that the desire of the City in this Plan to reduce the 85th percentile speeds to the current posted speed limit may not be achieved on all collector streets with implementation of this Plan. This Plan proposes the most feasible and best alternative. If more measures are installed on the collectors, the speeds may go down further, but the risk in diverting traffic onto adjacent



residential streets increases, and new impacts are generated. The table indicates that upon implementation, the anticipated enforceable speed limit would be reduced on the majority of the collectors with implementation of the Plan, except for Almond Avenue and Los Altos Avenue where, with and without traffic calming measures, the enforceable speed limit is anticipated to remain at 30 MPH. The speed on Almond Avenue and Los Altos Avenue will be reduced by 3 MPH (10%) with the implementation of traffic calming measures.

Implementation of the Traffic Calming Plan could have the potential for traffic to divert to other roadways and into adjacent neighborhoods as drivers will look for cut-through roadways without traffic calming measures. Locations where potential diversion could occur have been identified in this Plan. Follow-up studies may be needed to evaluate the measures of a project’s success and to determine if the traffic problem has shifted to other neighborhood streets, which is recommended at a later design phase.

Preliminary costs were developed for each collector street and based on the technical data and this cost, the collector streets were rated and ranked from highest to lowest priority as follows:

Corridor	Accident Category		Cost Category				Priority Intersection Category		Speed Reduction Category		Volume Category		Total Ranking (subtotal of all categories)
	# of Accidents	Ranking	Cost	Highest Traffic Volume	Cost Per Vehicle	Ranking	Total Points	Ranking	Avg Speed Reduction	Ranking	Highest Volume	Ranking	
Fremont Avenue	84	4	\$ 2,460,000	19,258	\$ 128	2	3	2	8	4	19,258	4	16
Springer Road	44	2	\$ 611,250	8,715	\$ 70	3	9	4	8	4	8,715	2	15
El Monte Avenue	80	4	\$ 997,500	7,294	\$ 137	2	11	4	7	3	7,294	2	15
W. Edith Avenue	89	4	\$ 232,500	6,189	\$ 38	4	4	2	5	3	6,189	2	15
Grant Road	40	2	\$ 1,207,500	20,563	\$ 59	3	2	1	9	4	20,563	4	14
Cuesta Drive	42	2	\$ 345,000	7,333	\$ 47	4	5	2	6	3	7,333	2	13
Miramonte Avenue	26	2	\$ 592,500	7,705	\$ 77	3	8	4	4	2	7,705	2	13
Almond Avenue	28	2	\$ 780,000	5,439	\$ 143	2	6	3	3	2	5,439	2	11
Covington Road	64	3	\$ 1,020,000	5,011	\$ 204	1	8	4	3	2	5,011	1	11
Los Altos Avenue	11	1	\$ 690,000	4,005	\$ 172	1	11	4	3	2	4,005	1	9
St. Joseph Avenue	0	1	\$ 307,500	4,041	\$ 76	1	4	4	0	2	4,041	1	9
Main Street	0	1	\$ 82,500	4,836	\$ 17	4	0	1	0	1	4,836	1	8

Notes:

For each category, each corridor is ranked on a weighted average scale with a given grade from 1 to 4, least to most critical. All categories are equally weighted.



1.0 Introduction

The Collector Traffic Calming Plan is a framework for implementation of traffic calming devices on collector roadways in the City of Los Altos. This Plan identifies specific devices and approximate spacing of devices necessary to achieve the desired speed ranges along the collector roadways. Actual placement and detailed design of devices will be determined during future phases of the project, which will likely occur when funding for projects is available.

A concept design was developed for Fremont Avenue between Springer Road and the City Boundary to the east. Measured traffic speeds along collectors in the City are well above the posted speed limits of 25 to 30 miles per hour (mph). According to the California Vehicle Code, police officers cannot use radar to enforce speed limits when the 85th percentile speed is more than 5 mph over the posted speed limit. The disparity between posted speeds and measured speeds clearly exceeds the 5 mph threshold. In order for the existing speed limits to be enforceable, either the speed limits need to be raised or traffic speeds need to be reduced.

Traffic calming devices selected for the corridors are within the framework of the City's Traffic Calming Program. Both vertical (raised crosswalks, speed tables, etc.) and horizontal (medians, bulbouts, roundabouts, etc.) devices were considered in the Traffic Calming Plan. In selection of the devices, consideration was given to the existing geometry of the roadway, line of sight, sidewalks and bicycle lanes, on-street parking and right-of-way. The final selection of the traffic calming measures, its design and placement, will require input from the community in the form of neighborhood meetings/workshops, City staff, and emergency service personnel.

Many of the collector roadways in the City provide access to residential driveways, schools, community facilities and parks. High speed and high traffic volume result in a variety of concerns for non-motorized transportation. On many corridors, pedestrians and bicycles share the road with the passenger vehicles. Reduction in speeds will greatly improve the walking and bicycling environment along the corridors. Devices such as bulbouts and raised crosswalks will greatly improve pedestrian visibility at crosswalks and at key intersections.

In preparation of this Plan, the City coordinated efforts with other concurrent studies such as the Bicycle Transportation Plan, Loyola Corners Project, Blach School Neighborhood Traffic Study, and the City's Intersection Prioritization rankings. As these reports evolve, the project team updated the existing and proposed condition maps to maintain consistency between the various reports. As projects develop from this Plan, it will be critical that key documents, such as those listed above, are taken into consideration in the preliminary and final design plans. Fire response times were evaluated and the provision of these measures is not expected to increase the response time to above 7 minutes per call for the 90 percentile of responses, except for Fremont Avenue from the Los Altos Fire Station as indicated.



This plan was developed in accordance with the City's General Plan and has found to be in compliance with the following policies from the Circulation Element in regards to reduced travel speeds, emergency access, roadway safety and streetscape design:

Policy 2.11: Achieve traffic volumes and speeds on collector and local streets that are compatible with the character of the adjacent land uses, the function of the street, and bicycle and pedestrian traffic.

Policy 2.17: Maintain adequate emergency access for all land uses.

Policy 2.19: Narrow street segments and intersection approaches at appropriate locations to improve pedestrian safety and reduce travel speeds.

Policy 2.20: Enhance driving safety in the community.

The traffic calming device recommendations are based on function, safety and aesthetics. Slower traffic resulting from functional traffic calming devices, properly placed, makes the streets safer for all modes of traffic. Landscaping improvements can be integrated with traffic calming devices to improve perception and acceptance. Removal of unnecessary asphalt concrete (AC) surfaces, where possible, adds landscape opportunities and promotes stormwater infiltration.

1. Removal of impermeable AC surfaces
 - Better water quality – infiltration / bio-filter area
 - Better tree growth and preservation of existing oaks and other trees
 - More landscape area – results in more visual interest, color and native plantings
2. Insertion of "way-finding" iconic elements; monoliths and signage icons identifying neighborhoods, streets and community.
3. Improved landscape and neighborhood character – Plantings in key visual areas to reduce feeling of too much pavement, and create special visual focal points.

The following table describes the benefits associated with each of the measures presented in the Traffic Calming Toolbox:



Table 1.1 : Traffic Calming Measure Benefits

Device	Intended Purpose	Speed Reduction
Bulbout	Reduce pedestrian crossing distance; improve sight distance	Limited
Meandering Roadways	Shift traffic to reduce speeds on long, straight sections	Up to 5%
Raised Crosswalk	Reduce speed; improve visibility of pedestrians	Up to 10%
Raised Median	Narrow travel way; provide pedestrian refuge	Up to 5%
Raised Intersection	Reduce speed; improve visibility of intersection	Up to 10%
Roundabout (standard)	Improve safety at intersection; reduce speeds through intersection	Up to 20%
Roundabout (mini)	Reduce speed through intersection	Up to 10%
Speed Table	Reduce speed through change in vertical elevation	Up to 10%
Surface Treatments	Improve visibility of crosswalks	Limited
Treated Bicycle Lanes	Improve visibility of bicycle lanes; visually narrow roadway	Limited



2.0 Existing Collector Traffic Conditions

Traffic volume data, speed data, and accident statistics were provided by the City of Los Altos Engineering Division and are based on Statewide Integrated Traffic Records System (SWITRS) and are the most recent information available (City of Los Altos Engineering and Traffic Speed Zone Surveys, 2007). This data formed the framework of the existing conditions analysis for the Plan.

There are 12 roadways in the City of Los Altos that are classified as collectors per the City of Los Altos General Plan. Most collectors are two lanes with no center median. Fremont Avenue and Grant Road are both divided roadways with either planted medians or striped medians through portions of the City of Los Altos.

- Almond Avenue between San Antonio Road and El Monte Avenue
- Covington Road between El Monte Avenue and Grant Road
- Cuesta Drive between San Antonio Road and Springer Road
- El Monte Avenue between Foothill Expressway and Springer Road
- Fremont Avenue between City Boundary (Stevens Creek) and Springer Road
- Grant Road between Foothill Expressway and City Boundary (Covington Road)
- Los Altos Avenue between West Edith Avenue and City Boundary (El Camino Real)
- Main Street between Foothill Expressway and San Antonio Road
- Miramonte Avenue between Fremont Avenue and City Boundary (Alegre Avenue)
- Springer Road between Foothill Expressway and City Boundary (Hollingsworth Drive)
- St. Joseph Avenue between Foothill Expressway and St. Mathew Way
- West Edith Avenue between Foothill Expressway and San Antonio Road

2.1 Travel Speeds

According to the City's *General Plan Circulation Element* (2002), two-lane roadways typically carry upwards of 18,000 vehicles per day (vpd) when traffic speeds range from 20 to 35 mph. **Figure 1** on page 12 presents the posted speed limits on the collectors. Travel time surveys were conducted by the City in 2007 on these roadways to determine the 85th percentile speed, or the speed



that 85 percent of the vehicles are traveling, when traffic can navigate at free-flow conditions. Speed survey data indicates that the 85th percentile speeds are significantly higher (7 to 14 mph) than the posted speed limit.

2.2 Volumes

Traffic volumes along the collector were reported by the City and are based on 2007 traffic count data. Average daily traffic volumes reported ranged from approximately 1,900 vpd to approximately 20,500 vpd. The highest volumes were reported along Grant Road between Fremont Street and Covington Road and along Fremont Avenue between SR-85 and Grant Road. Along these roadways, volumes exceeded 19,000 vpd. **Figure 1** on page 12 presents the daily traffic volumes on the collector streets in this study.

The majority of the collector streets do not have raised curbs, but only edge of pavement conditions that either transition into gravel shoulder or landscaping. The provision of traffic calming measures can be designed to either continue edge of pavement conditions or raised curbs. Los Altos is a bicycle-friendly city and shoulders and bike lanes are present on many of the City streets.

Los Altos is also a tree friendly city. The provision of traffic calming devices was selected in a manner to maintain existing trees and landscaping as feasibly practical. Many of the traffic calming measures will increase the permeable surfaces on the streets where the landscaping can be incorporated.

The implementation of many of the traffic calming measures may impact storm water runoff. The placement of the measure and actual measures are based on existing storm drain locations to minimize impact to the storm drain system. Bulbouts and vertical measures (e.g., raised crosswalks) should be designed to accommodate the existing stormwater management systems specific to each location.



This Page Intentionally Left Blank

Figure 1. Los Altos Collector Traffic Calming Plan Existing Conditions Map

Legend:

Average Daily Traffic (2007, Source: City)

= Number of Accidents 2000 to 2008 (Where Recorded)

● Class "A" Study Intersection (Traffic Commission Rank 13 - 15)

● Class "B" Study Intersection (Traffic Commission Rank 11 - 12)

● Class "C" Study Intersection (Traffic Commission Rank 7 - 10)

● Class "D" Study Intersection (Traffic Commission Rank 6 or less)

Bike Lanes located on Collectors (Draft Bike Plan 2010)

— Existing Class II
 — Existing Class III
 - - - Proposed Class III

VMS SPEED LIMIT SIGN
 VMS = Variable Message Sign (Radar Speed Sign)

/ ## MPH 85th% / Posted Speeds

*Priority Intersections rankings determined per Traffic Commission Agenda 7/14/09 in Appendix B

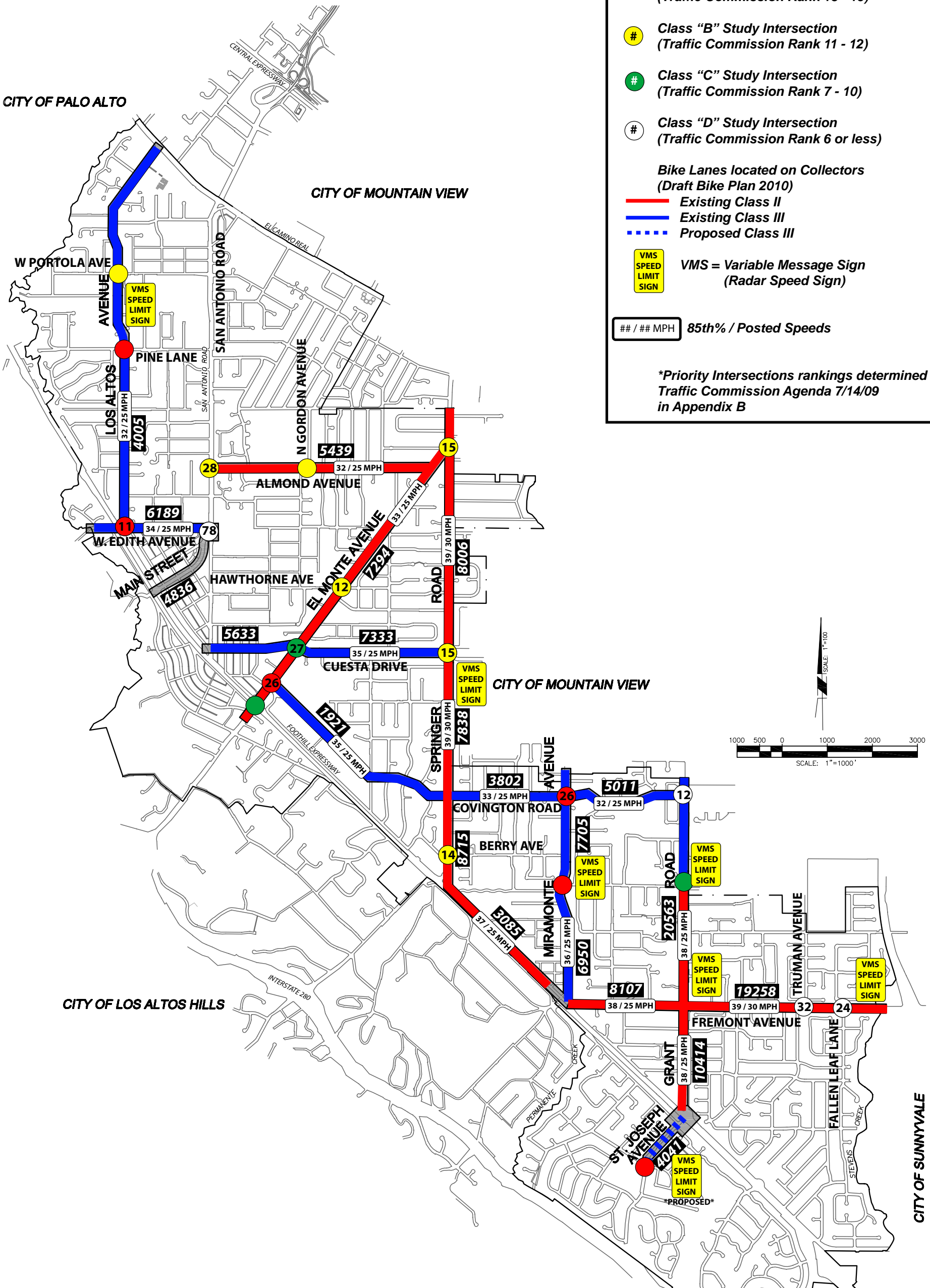

PROJ. NO. (G)	SHEET NO.
FILE NO.	OF
CITY OF LOS ALTOS, CALIFORNIA	
EXISTING CONDITIONS MAP	
DATE	REVISIONS
APPROVED FOR CONSTRUCTION	REVIEWED BY:
PLANS PREPARED BY: RBF CONSULTING	DESIGNED BY: RBF CONSULTING
CONSTRUCTION/SUPPLEMENTARY INFORMATION	PROJECT ENGINEER: RBF CONSULTING
CITY OF LOS ALTOS	



This Page Intentionally Left Blank



2.3 Accidents

Accident data, from SWITRS, was provided for years 2000 through 2008. A review of the accident data shows that the intersection of Main Street and West Edith Avenue has the highest number with 78 accidents reported during the eight year period. **Figure 1** on page 12 shows the number of accidents at various locations on the collector road system.

2.4 Prioritized Intersections

The City of Los Altos Traffic Commission has prioritized the need for intersection improvements throughout the City (see Appendix B). Ranking of the intersections is based on accident history, operational performance, and need for pedestrian and/or bicycle improvements. In October 2010, the City updated this list. The prioritization of intersections is identified in the existing conditions map (see Figure 1 on page 12 with green, yellow and red circles).



3.0 A Traffic Calming Toolkit for Los Altos Collector Streets

The following sections describe in detail, the traffic calming measures that were selected for use in the City's Collector Traffic Calming Plan. A description and purpose is provided for each measure along with a list of facts, advantages and disadvantages. A typical illustration and cross-section is also provided.

The following traffic calming measures are included in the City's Traffic Calming Toolkit for use on Collector Streets:

- Bulbouts
- Raised crosswalks
- Medians
- Chokers (only recommended on local (residential) streets in the Toolkit)
- Roundabouts
- Mini-Roundabouts (only recommended on local (residential) streets in the Toolkit)

Though the Toolkit only shows chokers and mini-roundabouts for the residential streets, the collector streets in the City are similar in nature to residential streets, therefore these two devices are being recommended in this Plan for many of the collectors.

In addition, the following measures are also recommended for implementation on the collectors in this Plan because they are traffic calming tools used in the industry that would calm traffic and improve safety at intersections and on streets:

- Raised intersections
- Surface treatment / mounds
- Meandering roadways (similar to Chicanes which are mentioned in the Toolkit, but recommended for local streets)
- Treated bike lanes
- Speed Tables

Roundabouts are designed per Caltrans and Federal Highway Administration (FHWA) design standards. All other measures are designed per standard industry practices e.g., Institute of Transportation Engineers (ITE), FHWA, etc. Typical costs indicated for each traffic calming measure does not include overhead costs (e.g., management, engineering, monitoring, and construction administration) of 50%. The selection of traffic calming devices was based on existing roadway geometry, constraints, characteristics and opportunity to slow traffic.



This Page Intentionally Left Blank



3.1 Bulbouts

(\$5,000 - \$10,000 per corner)

Description and Purpose

Curb extensions narrow the roadway by extending the curb into the parking lane or shoulder. Curb extensions may be placed at an intersection or along a roadway (see Choker). Curb extensions maintain a gap between the extension and the curb to prevent disruption to the gutter or drainage. The purpose of curb extensions is to narrow the width of the road and to slow motorists' speeds as they travel through the intersection, particularly when turning. The design of bulbouts could accommodate bicycles even if no bike lanes are striped on the approaches.



Fast Facts:

Can Be Used on Local Street	Yes
Can Be Used on Collector	Yes
Can Be Used on Arterial	Yes
Reduces Speed	Yes
Reduces Volume	No
Noise Impact	No
Restricts Access	No
Bicyclist Impact	Possible
Transit Impact	Possible
Parking Impact	Possible
Emergency Response Impact	Possible

Advantages

- Effective in reducing turning speeds
- Typically no impacts to parking, however site constraints such as non-standard parking and curb radii may require removal of on-street parking

Disadvantages

- Increases regular maintenance

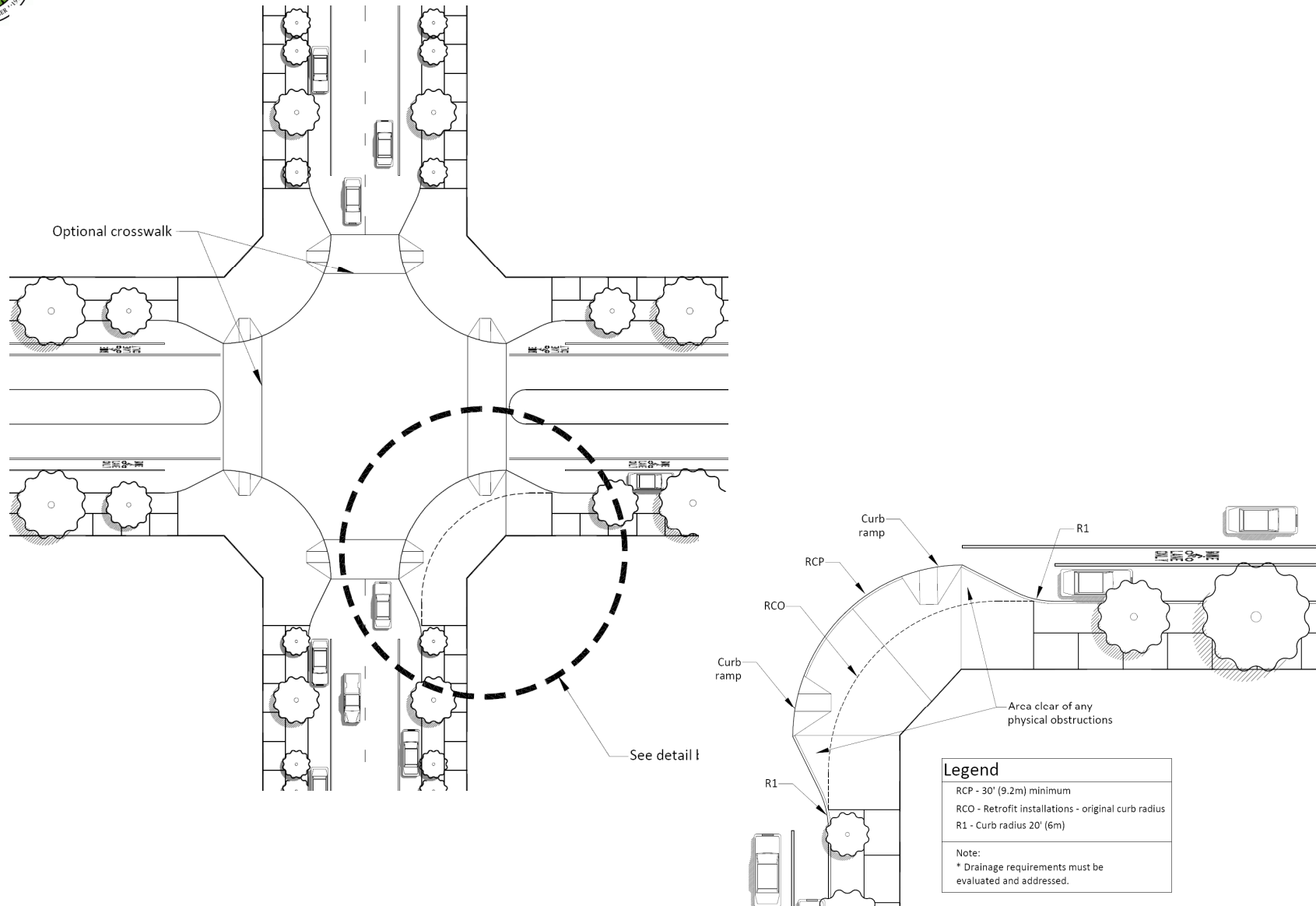



3.2 Chokers

(\$12,000 - \$15,000)

Description and Purpose

A choker is a pair of mid-block curb extensions that narrow the width of the travel way. Chokers are constructed to reduce motorists' speeds. The proposed chokers will accommodate 2-way vehicle flow and bike lanes parallel with the sidewalk.

Alternatively, bike lanes can also be placed to the inside of the chokers and allow for maintenance and street sweeper access.

Fast Facts:

Can Be Used on Local Street	Yes
Can Be Used on Collector	Yes
Can Be Used on Arterial	No
Reduces Speed	Yes
Reduces Volume	No
Noise Impact	No
Restricts Access	No
Bicyclist Impact	No
Transit Impact	Possible
Parking Impact	Yes
Emergency Response Impact*	No

* Possible impact if a center-raised median is constructed



Advantages

- Effective in reducing speeds
- Minimal effect on drainage
- Buffer for parked vehicles

Disadvantages

- Eliminates parking spaces

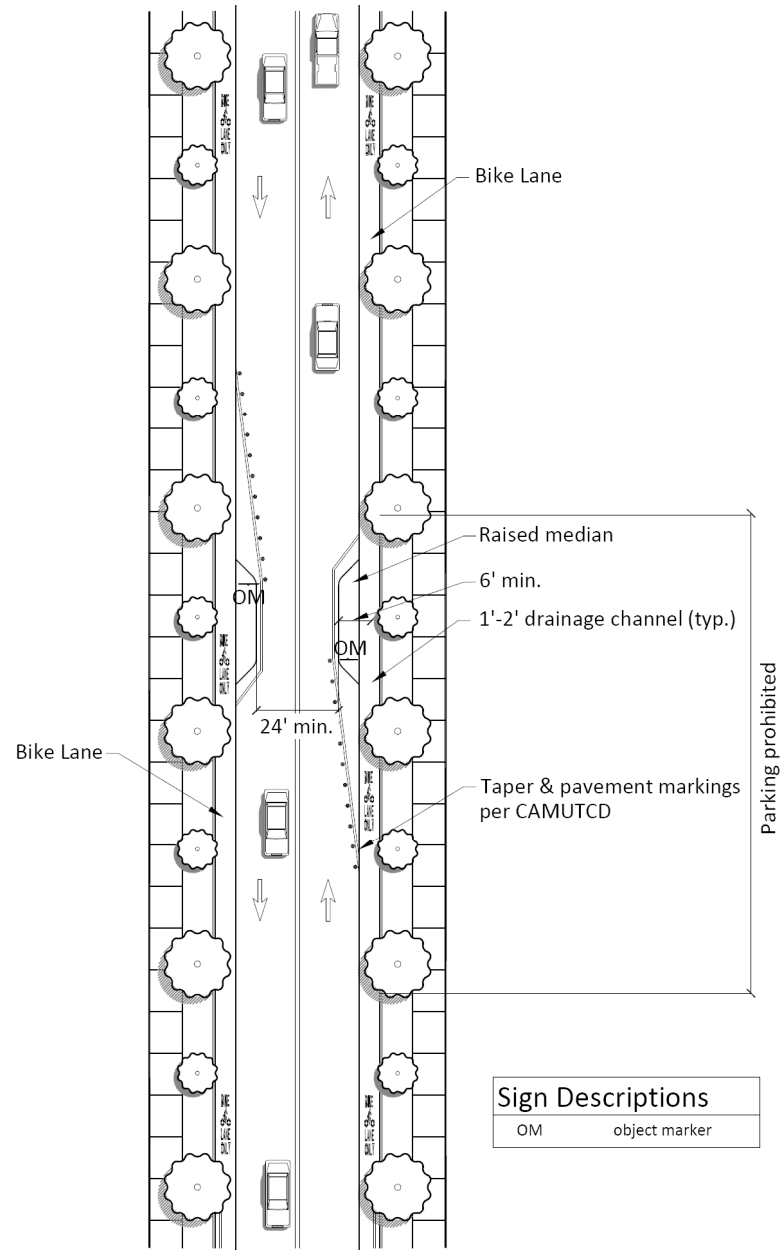



3.3 Raised Crosswalks

(\$10,000 - \$15,000)

Description and Purpose

A raised crosswalk is a flat-topped speed hump that requires motorists to reduce speeds as they proceed through the elevated section of the road. The proposed raised crosswalks will accommodate bike lanes in both directions with bike lanes at each side of the crosswalk. The cut-out for the bike lanes will allow bicyclist to avoid the raised portion of the crosswalk, but will alert the presence of pedestrian with treated pavement treatment.

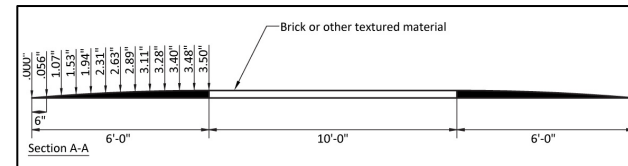

Fast Facts:

Can Be Used on Local Street	Yes
Can Be Used on Collector	Yes
Can Be Used on Arterial	No
Reduces Speed	Yes
Reduces Volume	Possible
Noise Impact	Yes
Restricts Access	No
Bicyclist Impact	No
Transit Impact	No
Parking Impact	Possible
Emergency Response Impact	Yes

Advantages

- Reduces speed
- Improves motorist visibility of pedestrians

Disadvantages

- Increases regular maintenance
- May require modifications to drainage
- May require loss of parking

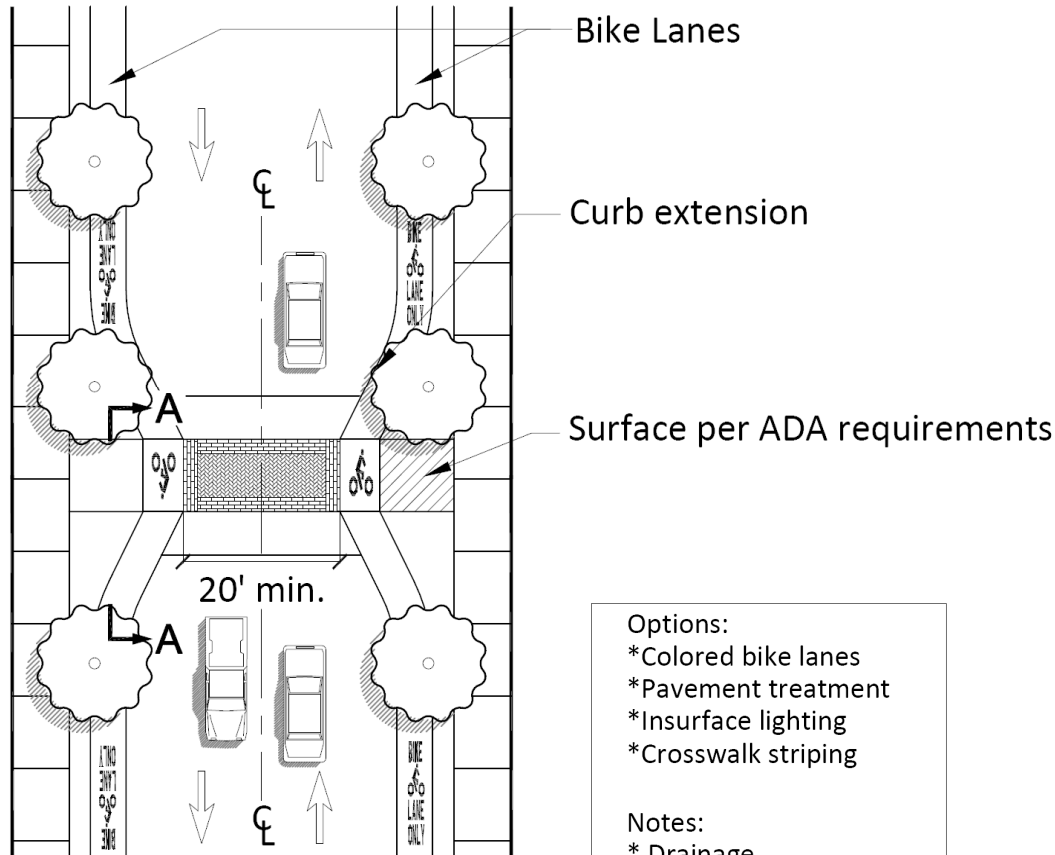

Bike Lanes

Curb extension

Surface per ADA requirements

20' min.

- Options:
- *Colored bike lanes
 - *Pavement treatment
 - *Insurface lighting
 - *Crosswalk striping

- Notes:
- * Drainage requirements must be evaluated and addressed.
 - * Crosswalks should meet traffic engineering requirements





3.4 Roundabouts

(\$250,000 - \$500,000)

Description and Purpose

Roundabouts are large raised circular islands placed in the middle of an intersection with channelized approaches. The purpose of roundabouts is to slow motorists's speeds as they maneuver around the circle to proceed through the intersection. Motorists entering the intersection must yield to circulating traffic. The dimensions of the roundabout can vary depending on the volume and types of vehicle usage.

Due to the reduction of vehicle speeds in and around the intersection, roundabouts can improve pedestrian crossing opportunities. Additionally, the splitter island refuge area provides the ability for pedestrians to focus on one traffic stream at a time while crossing.

Bicyclists using roundabouts have two options. They can merge with the flow of traffic through the roundabout or take the pedestrian walkway to cross the intersection. The use of the shared bicycle road marking and signs can be considered on the approaches to the roundabout, but the use of these signs are not indicated in the Manual on Uniform Traffic Control Devices (MUTCD).



Fast Facts:

Can Be Used on Local Street	Yes
Can Be Used on Collector	Yes
Can Be Used on Arterial	Yes
Reduces Speed	Yes
Reduces Volume	No
Noise Impact	No
Restricts Access	No
Bicyclist Impact	Possible
Transit Impact	Possible
Parking Impact	Yes
Emergency Response Impact	No

Advantages

- Reduces speed through an intersection
- Increases intersection capacity
- Reduces vehicle delay and queues
- Improves access

Disadvantages

- Increase regular maintenance
- May require loss of parking
- May require additional right-of-way

Vehicle & Pedestrian Conflict Points
Roundabout vs. Traditional Intersection

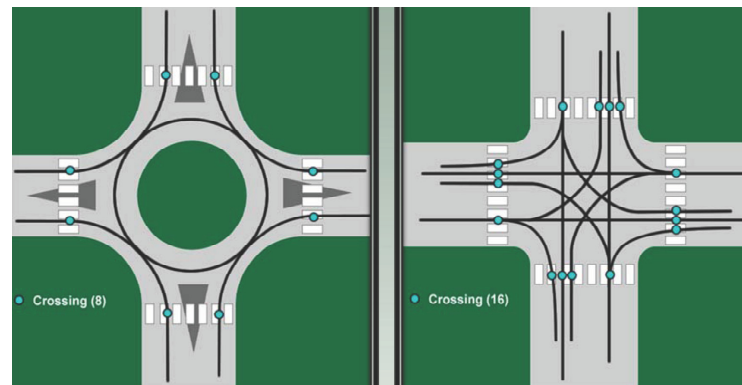

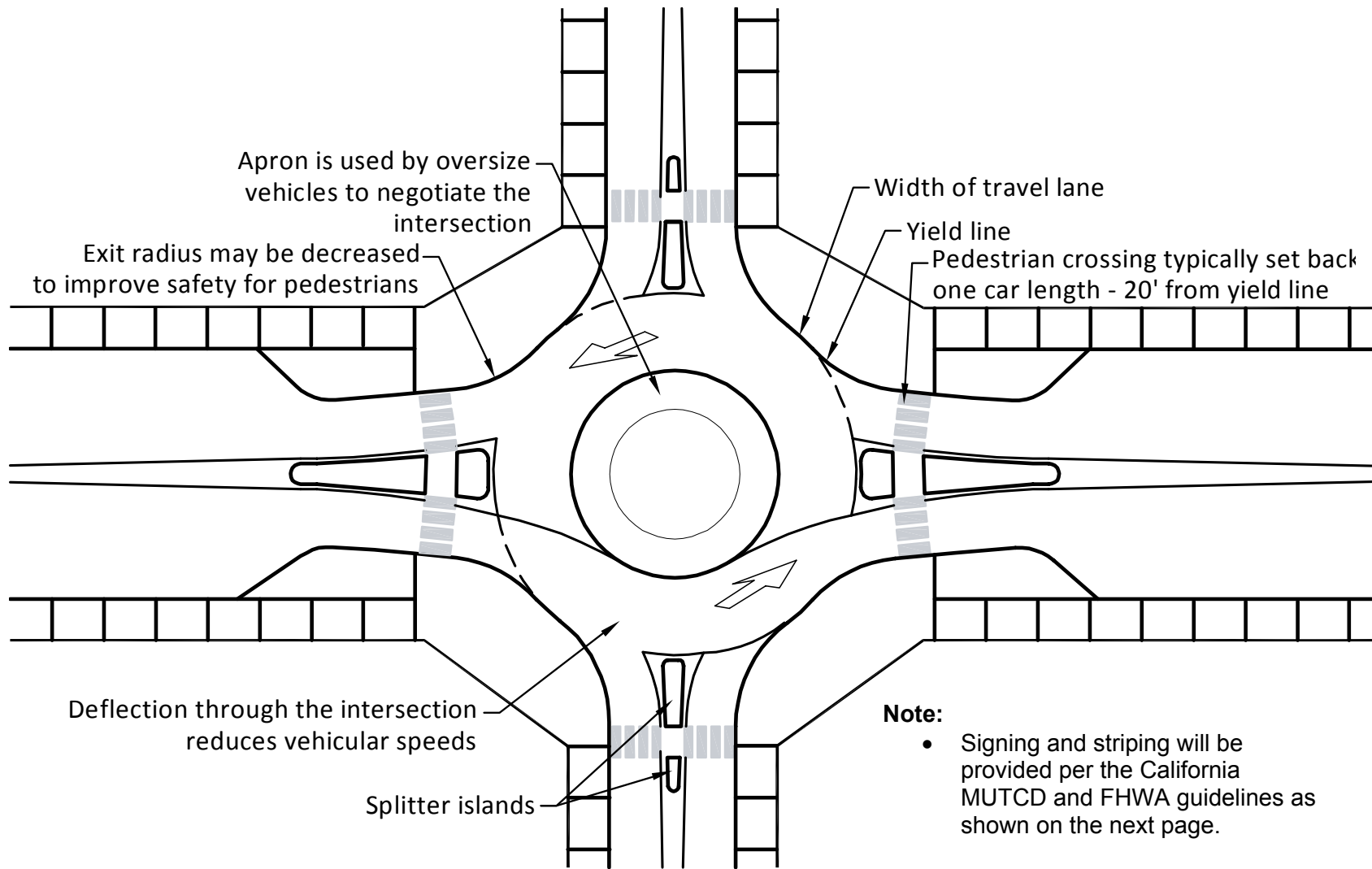

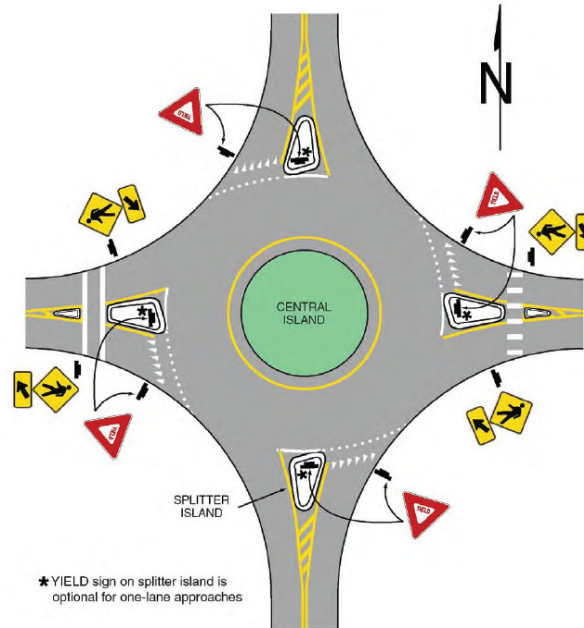
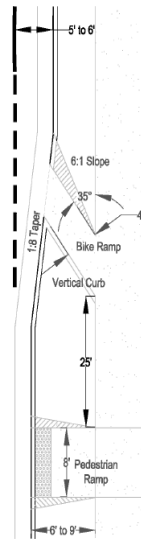
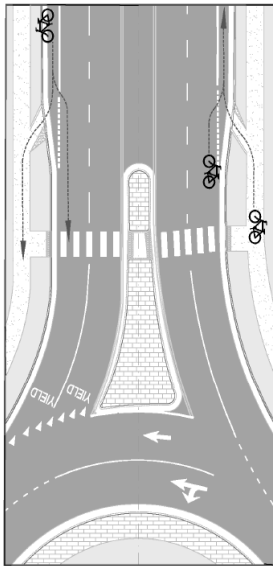
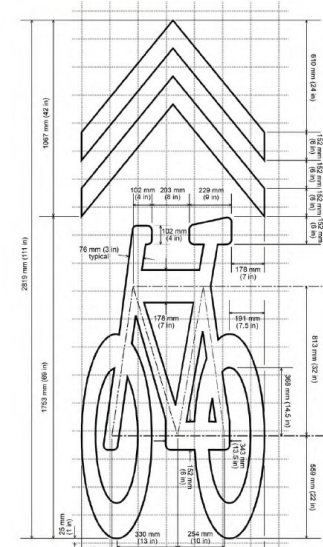

* YIELD sign on splitter island is optional for one-lane approaches





This Page Intentionally Left Blank



3.5 Mini-Roundabouts

(\$10,000 - \$25,000 excluding landscaping)

Description and Purpose

Traffic circles are raised circular islands constructed in the middle of an intersection. Traffic circles require motorists to maneuver around the circle to proceed through the intersection, which will result in motorist speed reduction.

Bicyclists will circulate a mini-roundabout in the same manner as a roundabout. Cyclists can circulate the intersection in the same manner as a motor vehicle. In the event cyclists desire to navigate the intersection as pedestrians, sidewalks and crosswalks are provided.



Fast Facts:

Can Be Used on Local Street	Yes
Can Be Used on Collector	Yes
Can Be Used on Arterial	No
Reduces Speed	Yes
Reduces Volume	No
Noise Impact	No
Restricts Access	No
Bicyclist Impact	Possible
Transit Impact	Possible
Parking Impact	Possible
Emergency Response Impact	No

Advantages

- Reduces speed through an intersection

Disadvantages

- Increases regular maintenance
- Wrong-way left-turns could occur

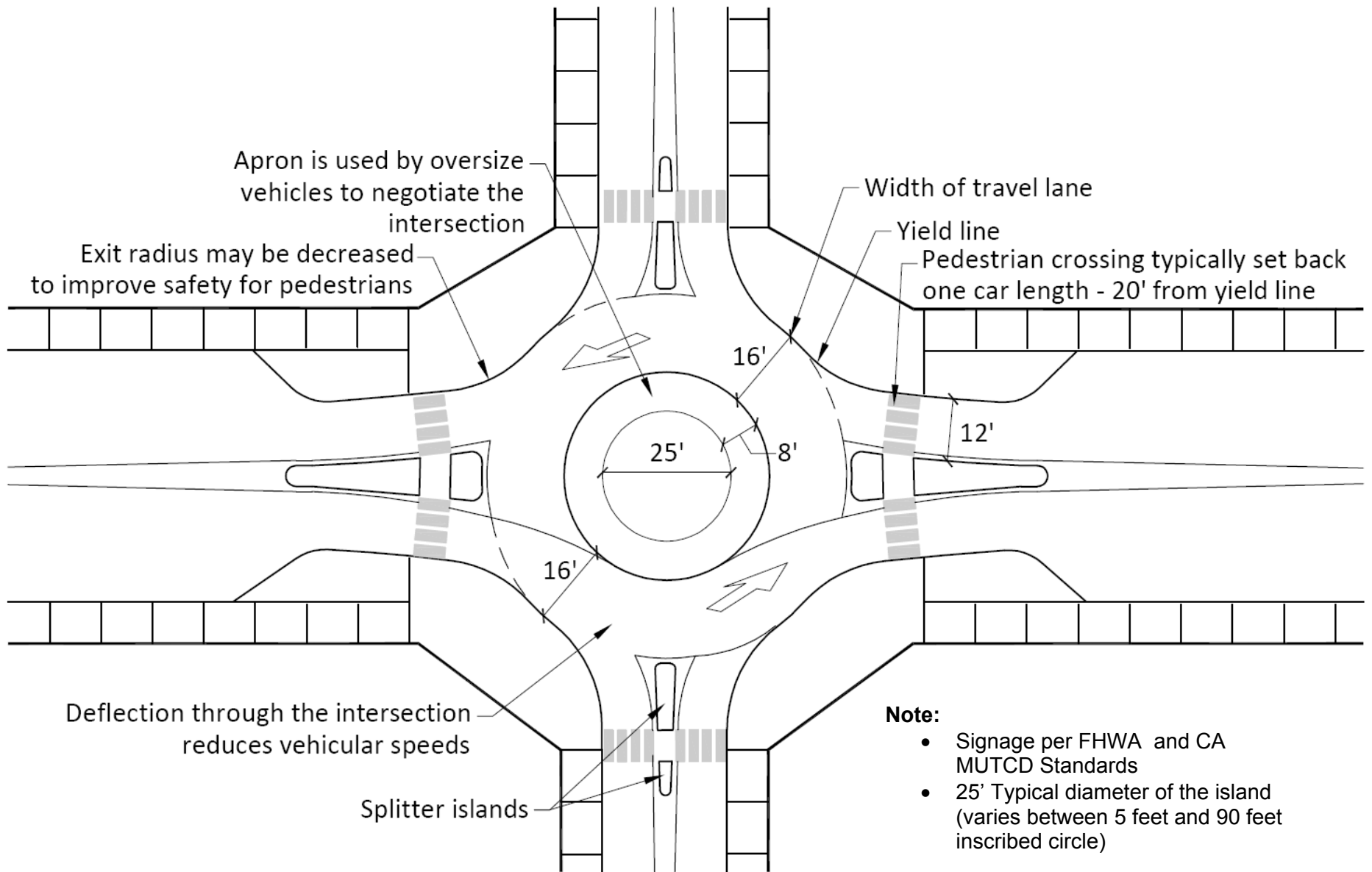



3.6 Medians

(\$250 per square foot)

Description and Purpose

A median is a raised island placed in the center of a roadway to reduce lane widths and slow vehicles down. Access to intermittent side streets or driveways may be maintained by providing breaks in the median.



Fast Facts:

Can Be Used on Local Street	Yes
Can Be Used on Collector	Yes
Can Be Used on Arterial	Yes
Reduces Speed	Yes
Reduces Volume	Possible
Noise Impact	No
Restricts Access	Possible
Bicyclist Impact	No
Transit Impact	No
Parking Impact	No
Emergency Response Impact	Possible

Advantages

- Reduces speeds

Disadvantages

- May impact access
- May increase trip lengths
- Only applicable on wide roads



This Page Intentionally Left Blank



3.7 Meandering Roadways

(\$30,000 - \$40,000)

Description and Purpose

Meandering roadways narrow the roadway with alternating curb extensions to create an S-shaped curve. Meandering roadways alter the road alignment and narrow the width of the travel lane in order to reduce motorists' speeds as they travel through the road segment. The proposed design will accommodate bike lanes in each direction parallel to the sidewalk.

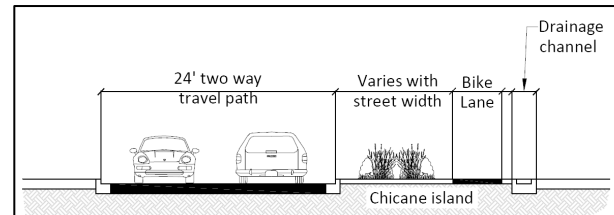

Fast Facts:

Can Be Used on Local Street	Yes
Can Be Used on Collector	Yes
Can Be Used on Arterial	No
Reduces Speed	Yes
Reduces Volume	No
Noise Impact	No
Restricts Access	No
Bicyclist Impact	No
Transit Impact	Yes
Parking Impact	Yes
Emergency Response Impact	No

Advantages

- Effective in reducing speeds

Disadvantages

- Increases regular maintenance
- Loss of parking spaces

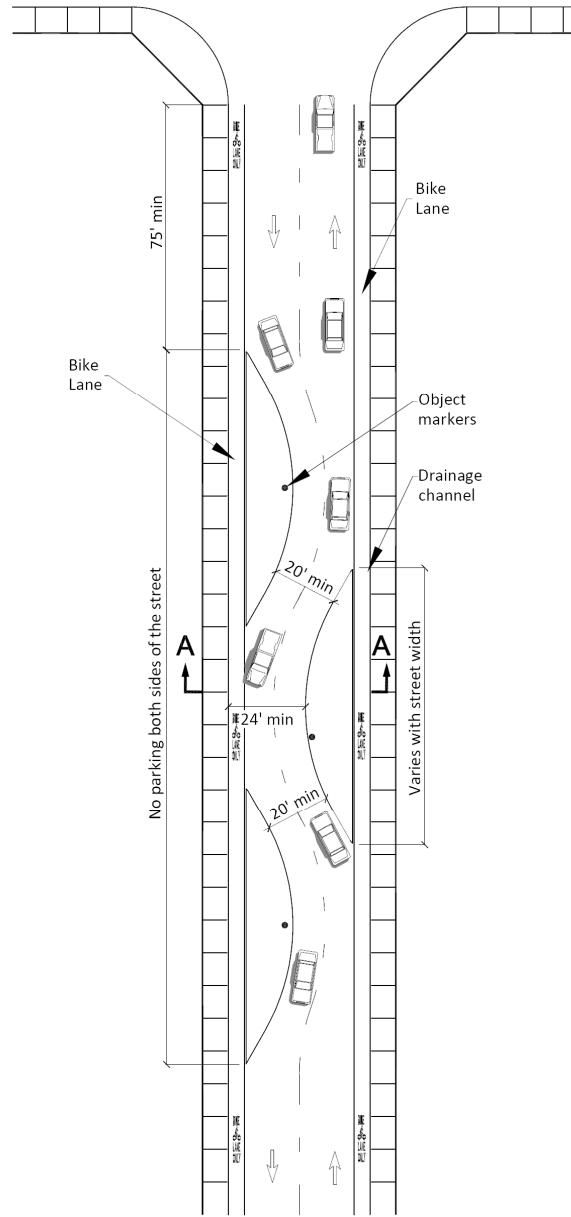



3.8 Raised Intersections

(\$125,000 - \$150,000)

Description and Purpose

A raised intersection requires motorists to reduce speeds as they proceed through an elevated intersection. Raised intersections are typically constructed to be three to four inches in height. Raised intersections are supplemented with appropriate striping and signage to adequately inform motorists of the traffic calming device.



Fast Facts:

Can Be Used on Local Street	Yes
Can Be Used on Collector	Yes
Can Be Used on Arterial	No
Reduces Speed	Yes
Reduces Volume	Possible
Noise Impact	Yes
Restricts Access	No
Bicyclist Impact	No
Transit Impact	No
Parking Impact	No
Emergency Response Impact	Yes

Advantages

- Reduces speed through an intersection
- May improve pedestrian safety

Disadvantages

- Expensive
- Increases regular maintenance

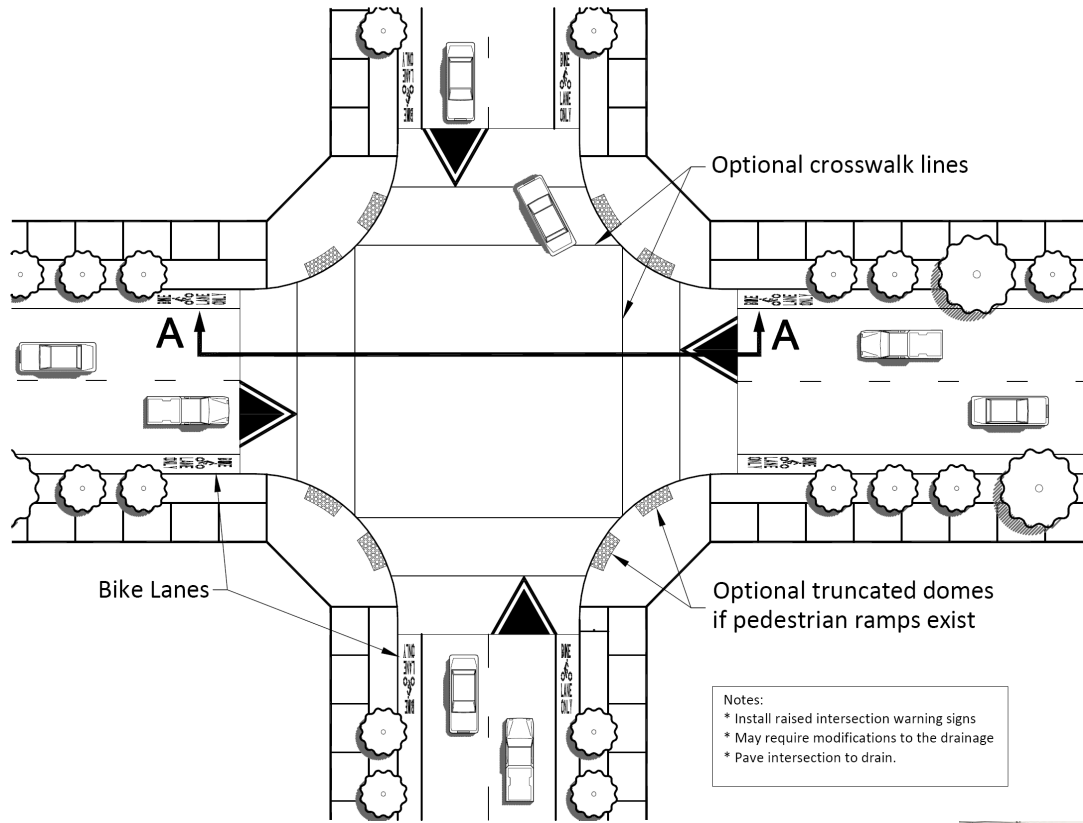

- Notes:
- * Install raised intersection warning signs
 - * May require modifications to the drainage
 - * Pave intersection to drain.



Figure 12. Suggested intersection and traffic calming design on First Street.



3.9 Speed Tables

(\$2,000 to \$4,000)

Description and Purpose

Speed tables are road humps that are flat on top and sometimes slightly longer. They are the same width as the street and rise to meet the grade of the sidewalk, providing safe and comfortable crossings for walkers and wheelchairs (and greater access for snow clearance than road humps). One benefit of speed tables is that people cross at the point where drivers decrease speed.



Fast Facts:

Can Be Used on Local Street	Yes
Can Be Used on Collector	Yes
Can Be Used on Arterial	No
Reduces Speed	Yes
Reduces Volume	No
Noise Impact	No
Restricts Access	No
Bicyclist Impact	Possible
Transit Impact	Yes
Parking Impact	No
Emergency Response Impact	No

Advantages

- Reduces speed along street segments
- They are smoother on large vehicles (such as fire trucks) than speed humps

Disadvantages

- May require loss of parking
- May impact street maintenance and emergency response times



3.10 Surface Treatments and Mounds

(\$2,000+ depending on type of treatment)

Description and Purpose

Changes in pavement color and texture used in interesting and visually attractive ways, can also have the effect of rumble strips. These paving treatments also: delineate and create awareness of a pedestrian crosswalk or haven; make a street appear narrower than it is to deter speeding; define a street from a sidewalk or a parking lane.

Mounds have a color and texture that are different from the pavement, and present a deflection in the pavement that motorists tend to avoid. Care should be taken in the installation of mounds as they may be perceived as roadway hazards.

Fast Facts:

Can Be Used on Local Street	Yes
Can Be Used on Collector	Yes
Can Be Used on Arterial	Yes
Reduces Speed	Yes
Reduces Volume	No
Noise Impact	No
Restricts Access	No
Bicyclist Impact	Possible
Transit Impact	No
Parking Impact	No
Emergency Response Impact	No



Advantages

- Reduces vehicle speeds
- Positive aesthetic value
- Does not slow emergency response vehicles

Disadvantages

- Noise
- Requires periodic maintenance



3.11 Treated Bike Lanes

(\$3,000 to \$6,000 per mile)

Description and Purpose

Bike lanes indicate a preferential or exclusive space for bicycle travel along a street. Color treated bike lanes have been found to provide more consistent separation between bicyclists and passing motorists. Marking bicycle lanes can also benefit pedestrians—as turning motorist slow and yield more to bicyclists, they will also be doing so for pedestrians. The Los Altos Collector Traffic Calming Plan accommodates the coloring of bike lanes in the critical transition area on the approach to an intersection, where right turning vehicles and bicycles share the same space. These areas are a minimum of 100 feet in length. Bike lane treatment should be incorporated in the paving material since paint can be slippery in wet weather conditions.



Optional Configurations

Advantages

- Enhances visibility of bike lanes and bicyclists
- Benefits pedestrians by slowing speeds

Disadvantages

- Requires more cost and maintenance than traditional bike lanes

This Page Intentionally Left Blank

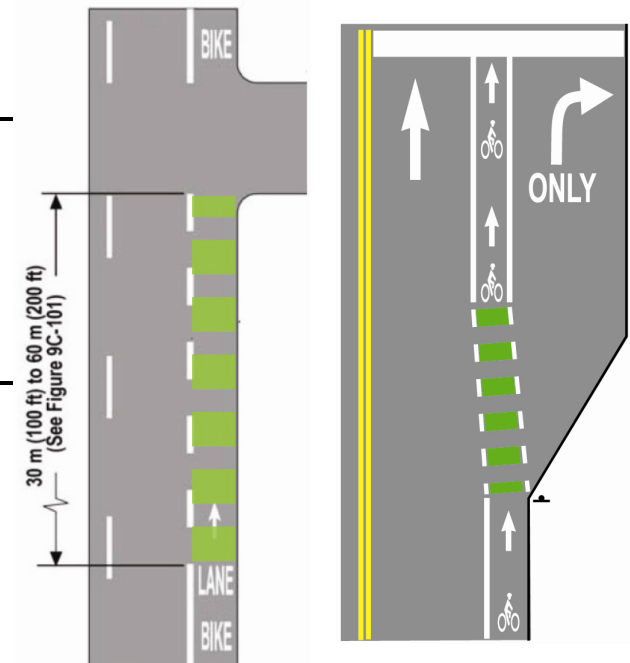

Fast Facts:

Can Be Used on Local Street	Yes
Can Be Used on Collector	Yes
Can Be Used on Arterial	Yes
Reduces Speed	Yes
Reduces Volume	No
Noise Impact	No
Restricts Access	No
Bicyclist Impact	No
Transit Impact	Possible
Parking Impact	Possible
Emergency Response Impact	No



4.0 The Collector Traffic Calming Plan

4.1 Plan Development

The Proposed Plan identifies feasible tools for implementation along each of the study collector roadways. The placement of the tools in the Plan is general. This document is intended to serve as a guide for implementation and selection of devices. Actual placement of and design of the traffic calming devices will be determined during the engineering design phase for each corridor.

Several factors were considered when selecting traffic calming tools for each corridor and in the development of the Plan:

- Surrounding Land Uses
- Parking
- Existing and Future Bicycle Facilities
- Pedestrian Access
- Right-of-Way
- Line of Sight
- Residential and Business Access
- Other Planned or Approved Projects

Traffic calming devices should compliment the surrounding land uses. In residential neighborhoods, careful consideration should be made in selecting devices that may affect parking and access, such as raised medians and chokers. Near schools, traffic calming devices that improve the visibility of pedestrians and bicyclists, such as bulbouts and raised crosswalks are typically recommended. In business districts, traffic calming devices such as surface treatments, narrowed and raised medians are beneficial both in slowing traffic, but also provide opportunities for street beautification and place making.

All traffic calming devices should be designed to fit within the existing right-of-way. Right-of-way affects the decisions to implement horizontal deflections such as meandering streets, chokers and raised medians. Narrowing the shoulder to accommodate such devices should only occur if sufficient distance can be maintained for pedestrian access around the proposed device (minimum 4 foot from edge of travel way).



Similarly, when bicycle facilities are provided along a corridor (Class II bicycle lanes and Class III bicycle routes), consideration should be made, at minimum, for maintaining the existing conditions of the bicycle facility. When chokers are installed, consideration should be made to place the bicycle lane on the outside of the medians as opposed to integrating bicycles with passenger vehicles. Where bicycle facilities do not currently exist, but are identified in the Bicycle Transportation Plan, design of a traffic calming plan for the corridor should integrate the proposed bicycle facility, where feasible, into the preliminary and final engineering of the corridor. Similarly, when bicycle facility projects move forward with the Bicycle Transportation Plan, consideration should be made with those projects for installation of the traffic calming devices included in this Plan. A review of the VTA Bicycle Technical Guidelines (2007) was conducted as part of this study and all proposed designs were found to be consistent with the VTA's bicycle design guideline requirements.

At intersections where line of sight is currently restricted from the side streets, bulbouts can be effective in improving line of sight if it is affected by horizontal obstructions (trees, landscaping, structures, parking). The bulbouts extend the curbs further into the intersection to help reduce the crossing distance for pedestrians. In doing so, the side street stop bar is also moved closer to the intersection, thereby improving line of sight. Many intersection improvements identified around school zones may be funded or may qualify for funding through the Safe Routes to School projects.

At intersections where high accidents have occurred, particular consideration should be made in selecting traffic calming devices for that location. Roundabouts are effective at reducing "T-Bone" accidents and are proven to reduce the severity of accidents at an intersection. If pedestrian or bicycle accidents are prevalent at intersections, improvements such as treated bicycle lanes, raised crosswalks, raised intersections and pavement treatments are effective at improving the visibility of bicycle facilities and intersections.

In all cases, traffic calming devices should be implemented in a series with the appropriate spacing to reduce speeds to the desired speed limit. A single device will only be effective at reducing speeds at that location, and as the vehicle travels away from the device, speeds tend to increase. When devices are properly spaced, drivers will not be able to speed up between devices and will therefore continue at a consistent speed along the corridor. Devices should be spaced between 300 and 750 feet apart, with wider spacing on streets posted 30 mph and narrower spacing for streets with posted 25 mph speed limits. On streets with higher traffic volumes, it may be desirable to maintain the maximum spacing along the corridor to prevent disruption to traffic flow or diversion.



4.2 Plan Summary

Figure 2 (see page 42) presents an overview map showing all of the proposed traffic calming measures in each collector. Each collector corridor is described in further detail below with information on the surrounding land uses, traffic concerns and recommended traffic calming measures.

Results from recent speed studies reveal that current 85th percentile traffic speeds are between 7 and 14 miles per hour over the posted speed limits along all the City of Los Altos collector streets included in this study. The reduction in speeds on the studied collectors, with implementation of the recommended measures in this Plan, would be expected to be between 5% and 20%. Table 4.1 indicates the estimated speed reductions.



Table 4.1: Estimated Speed Reduction Results

Street Name	2007 Traffic 85% Speed	Current Posted Speed Limit	Typical Reduction in Speed Based on Proposed TC Measures	Speed Reduction	Estimated Reduced Speed	Enforceable Speed Limit with Traffic Calming	Enforceable Speed Limit Without Traffic Calming
Fremont Avenue	37 - 39 MPH	30 MPH	5 - 20%	7 - 8 MPH	30 - 31 MPH	30 MPH	35 - 40 MPH
Springer Road	39 MPH	30 MPH	5 - 20%	8 MPH	31 MPH	30 MPH	40 MPH
Grant Road	38 MPH	25 MPH	5 - 20%	9 MPH	29 MPH	30 MPH	40 MPH
Miramonte Avenue	36 MPH	25 MPH	5 - 10%	4 MPH	32 MPH	30 MPH	35 MPH
Cuesta Drive	35 MPH	25 MPH	5 - 10%	6 MPH	29 MPH	30 MPH	35 MPH
Covington Road	32 - 35 MPH	25 MPH	5 - 10%	3 MPH	29 - 32 MPH	30 MPH	35 MPH
West Edith Avenue	34 MPH	25 MPH	5 - 10%	5 MPH	29 MPH	30 MPH	35 MPH
El Monte Avenue	33 MPH	25 MPH	5 - 20%	7 MPH	26 MPH	25 MPH	35 MPH
Almond Avenue	32 MPH	25 MPH	10%	3 MPH	29 MPH	30 MPH	30 MPH
Los Altos Avenue	32 MPH	25 MPH	5 - 10%	3 MPH	29 MPH	30 MPH	30 MPH
St. Joseph Avenue	No Speed Survey Data	25 MPH	5 - 10%	3 MPH	NA	NA	NA
Main Street	No Speed Survey Data	25 MPH	5 %	1 MPH	NA	NA	NA

Note:

Yellow highlighted rows achieve the goal.

Pink highlighted rows are streets that will remain at 30 MPH with or without traffic calming measures

Green highlighted rows are streets that achievement depends on the traffic survey speed

*Enforceable speed limit is 25 MPH in school zones.

Table 4.1 indicates that the desire of the City in this Plan to reduce the 85th percentile speeds to the posted 25 MPH speed limit may not be achieved on all collector streets with implementation of this Plan. If more measures are installed on the collectors, the speeds may go down further, but the risk in diverting traffic onto adjacent residential streets increases, and new impacts are generated. The table indicates that upon implementation, the anticipated enforceable speed limit would be reduced on the majority of the collectors with implementation of the Plan, except for Almond Avenue and Los Altos Avenue where, with and without traffic calming measures, the enforceable speed limit is anticipated to remain at 30 MPH though there should be a reduction in the speeds on these two streets.

Figure 2: Los Altos Collector Traffic Calming Plan Proposed Improvements Map

PRELIMINARY

Legend:

- New Standard Roundabout
 - New Mini-Roundabout
 - ▲ Bulbout (At Intersection)
 - Raised Intersection
 - Raised Crosswalk / Speed Table
 - Surface Treatment / Mound
 - Median
 - Choker
 - ~ Meandering Roadway
- *Note: Treated Class II bicycle lanes to be considered along the following Collectors*
- Fremont Avenue
 - Grant Road
 - Springer Road
 - El Monte Avenue
- Santa Clara County Fire Station

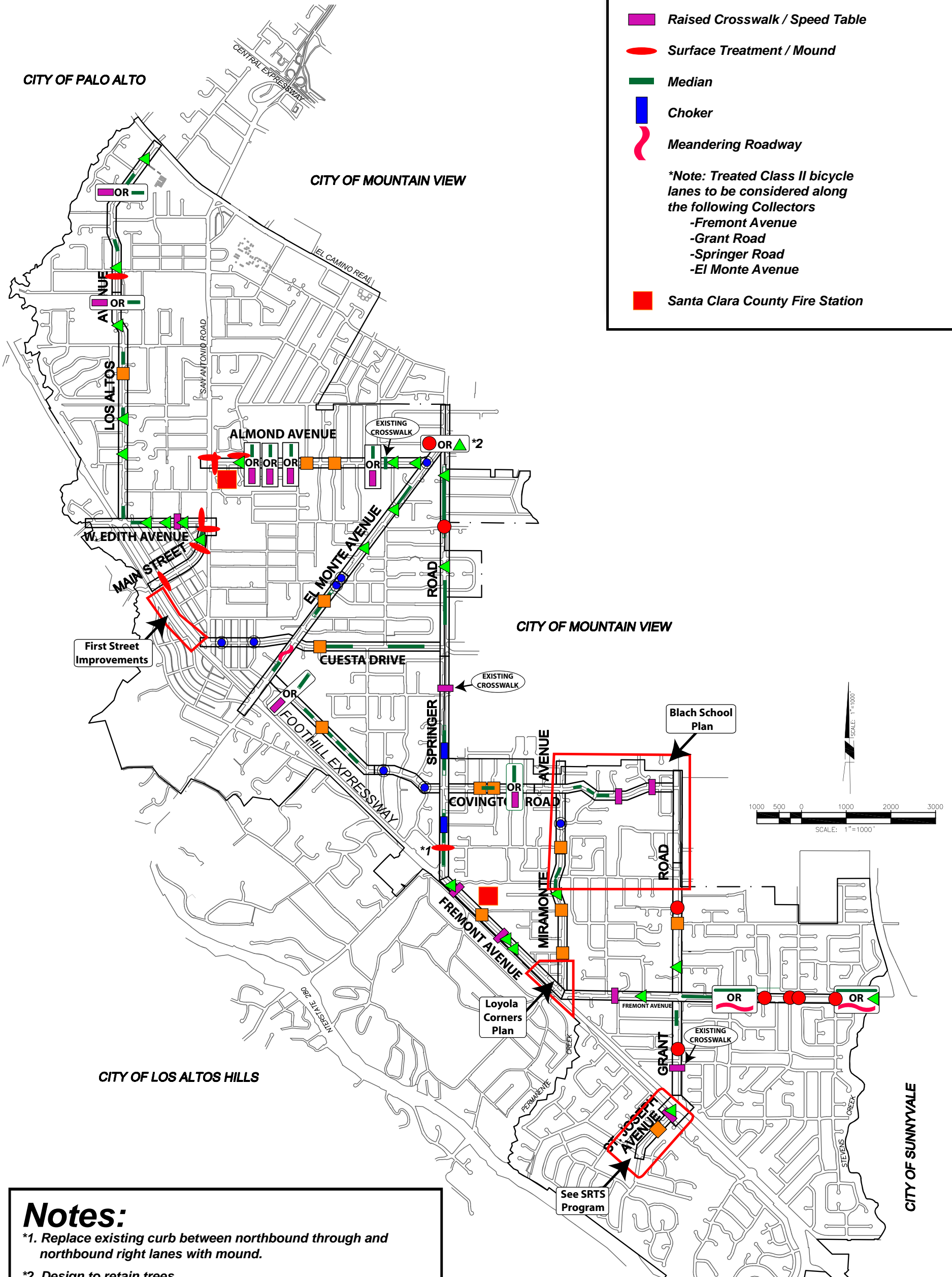

Notes:

- *1. Replace existing curb between northbound through and northbound right lanes with mound.
- *2. Design to retain trees.

PROJ. NO. (S)	SHEET NO.
FILE NO.	OF
CITY OF LOS ALTOS, CALIFORNIA	
PROPOSED IMPROVEMENTS MAP	
DATE	REVISIONS
APPROVED FOR CONSTRUCTION:	REVIEWED BY:
PLANS PREPARED BY:	DESIGN:
CONSTRUCTION SUPERVISOR:	CONSTRUCTION SUPERVISOR:
PROJECT ENGINEER:	PROJECT ENGINEER:
CITY OF LOS ALTOS	



This Page Intentionally Left Blank



This Page Intentionally Left Blank



4.3 Almond Avenue: San Antonio Road to El Monte Avenue

Surrounding Land Uses: Between San Antonio Road and El Monte Avenue, Almond Avenue consists of residential neighborhoods and provides direct access to Los Altos High School and Almond Elementary School. Intersections are offset and closely spaced creating short blocks between intersections and driveways.



Traffic Concerns: Almond Avenue carries over 5,000 vehicles per day, with heavy traffic flow during the school drop-off and pick-up time periods. Measured traffic speeds exceed the speed limit by 7 mph, which restricts enforcement by radar. Although schools are located along Almond Avenue, sidewalks are intermittent. Where sidewalks are not provided, pedestrians walk alongside bicycles and passenger vehicles within the provided Class II bike lanes.

Recommended Tools: The tools selected for this section aim to reduce traffic speeds to conform with the posted speed limit and improve the pedestrian environment, particularly for students walking to and from school. The characteristics of Almond Avenue, including traffic volume and right-of-way, are suitable for vertical and horizontal deflection. To successfully slow traffic to the desired speed range (25-30 mph), the devices should be spaced close together (500 to 800 feet) and should work together as a system to maintain consistently lower speeds along the corridor.

As such, the following devices were identified as feasible:

- **Raised Medians:** reduce speeds up to 5% by narrowing the width of the travel lanes
- **Raised Intersections:** up to 10% reduction in speed
- **Mini-Roundabouts:** up to 10% reduction in speed
- **Bulbouts:** reduce pedestrian crossing distance and improve visibility of pedestrians
- **Surface Treatments:** changes pavement surface to draw drivers' attention

Working together, these traffic calming devices are anticipated to result in an average 5 to 10 mph decrease in speed along Almond Avenue. Medians and bulbouts are recommended to visually and physically narrow the roadway to reduce speeds and provide improved crossing conditions for pedestrians. A mini-roundabout is proposed near the intersection of Almond Avenue and El Monte Avenue. A sequence of two raised medians and raised medians or raised crosswalks are proposed between the school sites to enforce reduced speeds along the corridor. Surface treatments are recommended around the corner of Almond Avenue and San Antonio Road to draw drivers' attention as they approach the school.



Existing Conditions

Legend:

Average Daily Traffic (2007, Source: City)

= Number of Accidents 2000 to 2008 (Where Recorded)

- Class "A" Study Intersection (Traffic Commission Rank 13 - 15)
- Class "B" Study Intersection (Traffic Commission Rank 11 - 12)
- Class "C" Study Intersection (Traffic Commission Rank 7 - 10)
- Class "D" Study Intersection (Traffic Commission Rank 6 or less)

Bike Lanes located on Collectors (Draft Bike Plan 2010)

- Existing Class II
- Existing Class III
- Proposed Class III

VMS = Variable Message Sign (Radar Speed Sign)

VMS SPEED LIMIT SIGN

/ ## MPH 85th% / Posted Speeds



Proposed Traffic Calming

Legend:

- New Standard Roundabout
- New Mini-Roundabout
- ▲ Bulbout (At Intersection)
- Raised Intersection
- Raised Crosswalk / Speed Table
- Surface Treatment / Mound
- Median
- Choker
- ~ Meandering Roadway

*Note: Treated Class II bicycle lanes to be considered along the following Collectors

- Fremont Avenue
- Grant Road
- Springer Road
- El Monte Avenue

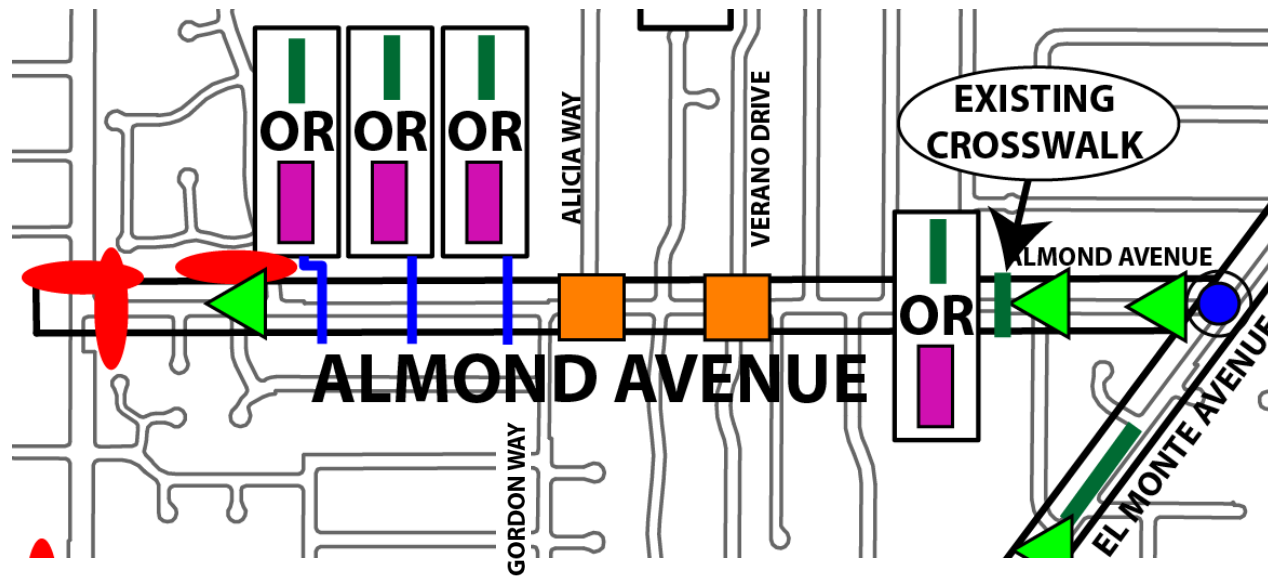



4.4 Covington Road: Grant Road to Springer Road

Surrounding Land Uses: Between Grant Road and Springer Road, Covington Road consists of single-family residential homes and provides access to the Blach Junior High School and a preschool. Two yellow pedestrian crossings are marked along the street fronting the school and sports club, which serves as a youth camp. An existing Class III bike lane is provided along Covington Road.



Traffic Concerns: Measured traffic speeds exceed the speed limit by 8 mph, which restricts enforcement by radar. Covington Road carries over 5,000 vehicles per day. Intermittent sidewalks and Class III bicycle facilities are currently provided. Where sidewalks are not provided, pedestrians walk alongside bicycles and passenger vehicles. Due to the prevalence of accidents, particularly at the intersection of Covington Road and Miramonte Avenue, this street is considered a priority area.

Recommended Tools: The tools selected for this section aim to reduce traffic speeds to conform with the posted speed limit and improve the pedestrian environment, particularly for pedestrians walking to and from the preschool and sports club. The characteristics of Covington Road are suitable for both vertical and horizontal deflection traffic calming measures. To successfully slow traffic to within 5 mph of the posted speed limit, the devices should be spaced close together (500 to 800 feet). Although spacing of the devices is critical to maintaining consistent speeds, considerations should be made when selecting the location of the devices to minimize impacts to parking and access to residential driveways.

As such, the following devices were identified as feasible:

- **Raised Medians:** reduce speeds up to 5% by narrowing the width of the travel lanes
- **Raised Crosswalks:** up to 20% reduction in speed
- **Raised Intersections:** up to 10% reduction in speed

Working together, the traffic calming devices are anticipated to result in an approximately 10 mph decrease in speed along Covington Road between Grant Road and Springer Road, with greater speed reduction through the sequence of two raised intersections near Siena Avenue. Raised medians are proposed between Miramonte Avenue and the preschool. Raised crosswalks are proposed to replace the existing crosswalks fronting the preschool to serve as traffic calming measures and improve crossing facilities. The raised medians will provide refuge areas in the middle of the street and buffer pedestrians as they cross both directions of traffic. The implementation of raised intersections, raised crosswalks and raised medians creates a repetitive pattern to enforce reduced speeds, and improve crossing conditions for pedestrians through the use of vertical deflection.



Existing Conditions

Legend:

Average Daily Traffic (2007, Source: City)

= Number of Accidents 2000 to 2008 (Where Recorded)

- Class "A" Study Intersection (Traffic Commission Rank 13 - 15)
- Class "B" Study Intersection (Traffic Commission Rank 11 - 12)
- Class "C" Study Intersection (Traffic Commission Rank 7 - 10)
- Class "D" Study Intersection (Traffic Commission Rank 6 or less)

Bike Lanes located on Collectors (Draft Bike Plan 2010)

- Existing Class II
- Existing Class III
- Proposed Class III

VMS = Variable Message Sign (Radar Speed Sign)

/ ## MPH 85th% / Posted Speeds

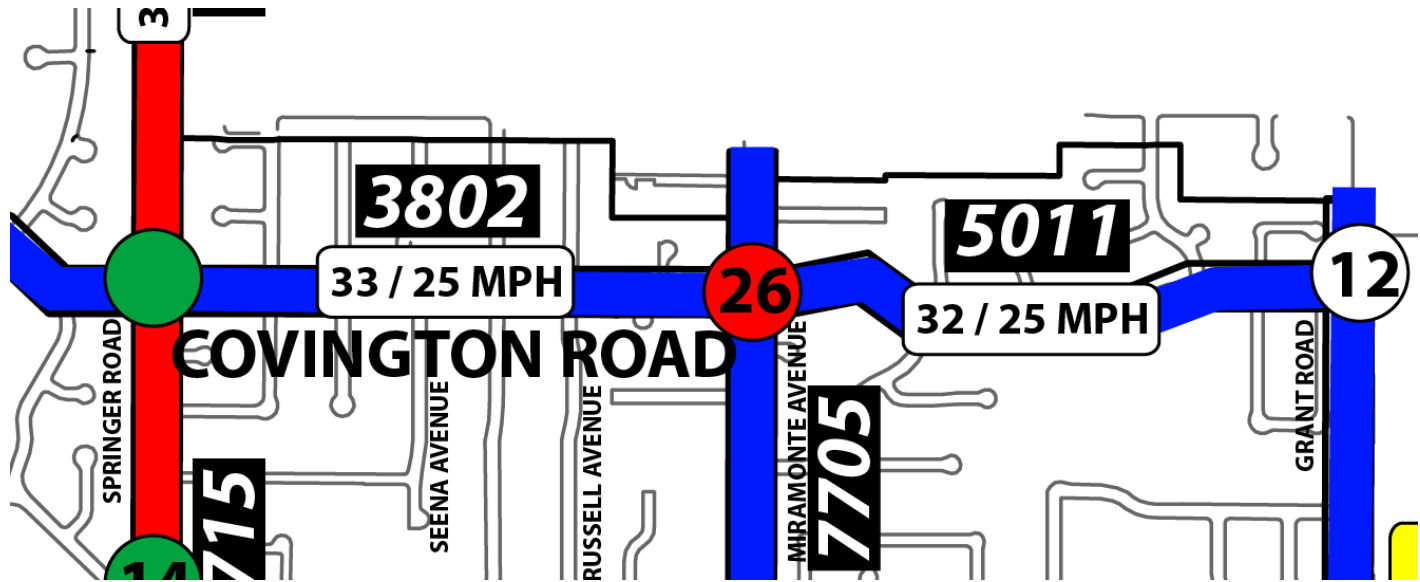

Proposed Traffic Calming

Legend:

- New Standard Roundabout
- New Mini-Roundabout
- ▲ Bulbout (At Intersection)
- Raised Intersection
- Raised Crosswalk / Speed Table
- Surface Treatment / Mound
- Median
- Choker
- ~ Meandering Roadway

**Note: Treated Class II bicycle lanes to be considered along the following Collectors*

- Fremont Avenue
- Grant Road
- Springer Road
- El Monte Avenue

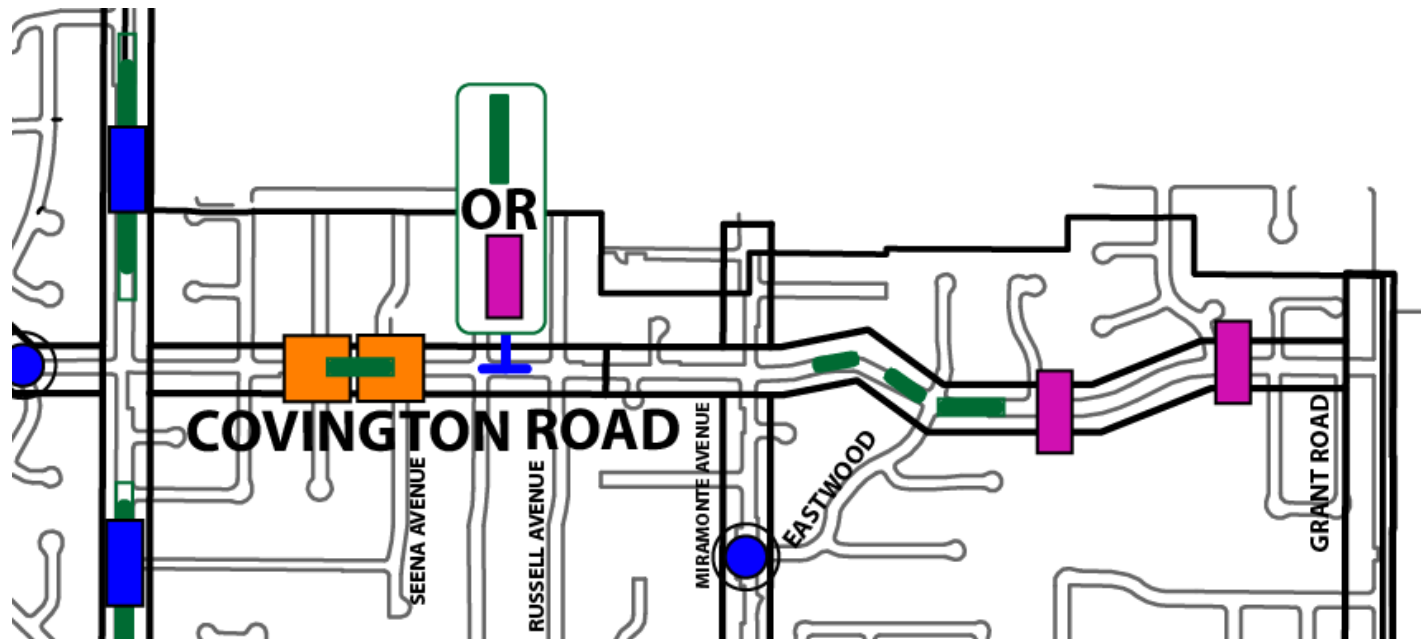



4.5 Covington Road: Springer Road to El Monte Avenue

Surrounding Land Uses: Between Springer Road and El Monte Avenue, Covington Road consists of single-family residential homes. Access to Covington Elementary School and St. William Catholic Church are also provided along Covington Road. A yellow pedestrian crosswalk is marked along the street fronting the elementary school.



Traffic Concerns: Measured traffic speeds exceed the speed limit by 10 mph, which restricts enforcement by radar. This segment of Covington Road carries less than 2,000 vehicles per day, but has peak activity surrounding the school during drop-off and pick-up times. Speeding is most likely due to the low traffic volume and the long, straight, uninterrupted sections. Intermittent sidewalks and Class III bicycle facilities are currently provided. Where sidewalks are not provided, pedestrians walk alongside bicycles and passenger vehicles. For the majority of the corridor, on-street parking is not permitted.

Recommended Tools: The tools selected for this section aim to reduce traffic speeds and improve the pedestrian environment particularly near the existing church and school sites. The characteristics of Covington Road, including traffic volume and right-of-way, are suitable for vertical and horizontal deflection traffic calming measures. To successfully slow traffic to within 5 mph of the posted speed limit, the devices should be spaced close together (500 to 800 feet) and should work together as a system to maintain consistently lower speeds along the corridor.

As such, the following devices were identified as feasible:

- **Raised Medians:** reduce speeds up to 5% by narrowing the width of the travel lanes
- **Raised Crosswalk:** up to 20% reduction in speed
- **Raised Intersection:** up to 10% reduction in speed
- **Mini-Roundabouts:** 10-15% reduction in speed

Working together, the traffic calming devices are anticipated to result in an approximately 10 mph decrease in speed along Covington Road between Springer Road and El Monte Avenue, with greater speed reduction through the sequence of two mini-roundabouts between Springer Road and Campbell Avenue. Mini-roundabouts will maintain traffic flow while significantly reducing speeds through the intersection. Raised medians are proposed between Campbell Avenue and El Monte Avenue. A raised crosswalk is proposed to replace the existing crosswalk fronting the elementary school to serve as a traffic calming measure and improve crossing facilities.



Existing Conditions

Legend:

- ### Average Daily Traffic (2007, Source: City)
- # = Number of Accidents 2000 to 2008 (Where Recorded)
- Class "A" Study Intersection (Traffic Commission Rank 13 - 15)
- Class "B" Study Intersection (Traffic Commission Rank 11 - 12)
- Class "C" Study Intersection (Traffic Commission Rank 7 - 10)
- Class "D" Study Intersection (Traffic Commission Rank 6 or less)
- Bike Lanes located on Collectors (Draft Bike Plan 2010)
 - Existing Class II
 - Existing Class III
 - Proposed Class III
- VMS SPEED LIMIT SIGN VMS = Variable Message Sign (Radar Speed Sign)
- ## / ## MPH 85th% / Posted Speeds



Proposed Traffic Calming

Legend:

- New Standard Roundabout
- New Mini-Roundabout
- ▲ Bulbout (At Intersection)
- Raised Intersection
- Raised Crosswalk / Speed Table
- Surface Treatment / Mound
- Median
- Choker
- ~ Meandering Roadway

*Note: Treated Class II bicycle lanes to be considered along the following Collectors
 -Fremont Avenue
 -Grant Road
 -Springer Road
 -El Monte Avenue





4.6 Cuesta Drive: Springer Road to El Monte Avenue

Surrounding Land Uses: Between Springer Road and El Monte Avenue, Cuesta Drive consists of single-family residential homes. Access to the homes is taken directly from Cuesta Drive. Parking is allowed on both sides of the street.

Traffic Concerns: Measured traffic speeds exceed the speed limit by 10 mph, which restricts enforcement by radar. Cuesta Drive carries over 7,000 vehicles per day, which is high compared to similar collector roadways in the City of Los Altos. Cuesta is an east-west connector between San Antonio Road and Springer Road. Therefore, this roadway is used as a thoroughfare for many users. Sidewalks and Class III bicycle facilities are currently provided.



Recommended Tools: The tools selected for this section aim to reduce traffic speeds to conform with the posted speed limit. The characteristics of Cuesta Drive are suitable for vertical and horizontal deflection. The ability to apply horizontal devices such as bulbouts or chokers may be limited due to restricted right-of-way, lack of sidewalk and on-street parking. Where horizontal devices are selected, sufficient distance along the shoulder should be provided for pedestrians and bicycles along the shoulder.

To successfully slow traffic to the desired speed range (25-30 mph) the devices should be spaced close together (500 to 800 feet) and should work together as a system to avoid diversion of traffic to local streets and to maintain consistently lower speeds along the corridor. All proposed improvements will compliment the Blach School Neighborhood Traffic Study.

As such, the following devices were identified as feasible:

- **Raised Medians:** reduce speeds up to 5% by narrowing the width of the travel lanes
- **Raised Intersection:** up to 10% reduction in speed

Working together, these traffic calming devices are anticipated to result in an average 5 to 10 mph decrease in speed along Cuesta Drive. Medians are recommended to visually and physically narrow the roadway to reduce speeds through much of the length of the corridor. A raised intersection is proposed at the intersection of Cuesta Drive and Arboleda Drive, which provides access to the southern portion of the neighborhood.



Existing Conditions

Legend:

Average Daily Traffic (2007, Source: City)

= Number of Accidents 2000 to 2008 (Where Recorded)

- Class "A" Study Intersection (Traffic Commission Rank 13 - 15)
- Class "B" Study Intersection (Traffic Commission Rank 11 - 12)
- Class "C" Study Intersection (Traffic Commission Rank 7 - 10)
- Class "D" Study Intersection (Traffic Commission Rank 6 or less)

Bike Lanes located on Collectors (Draft Bike Plan 2010)

- Existing Class II
- Existing Class III
- Proposed Class III

VMS SPEED LIMIT SIGN VMS = Variable Message Sign (Radar Speed Sign)

/ ## MPH 85th% / Posted Speeds

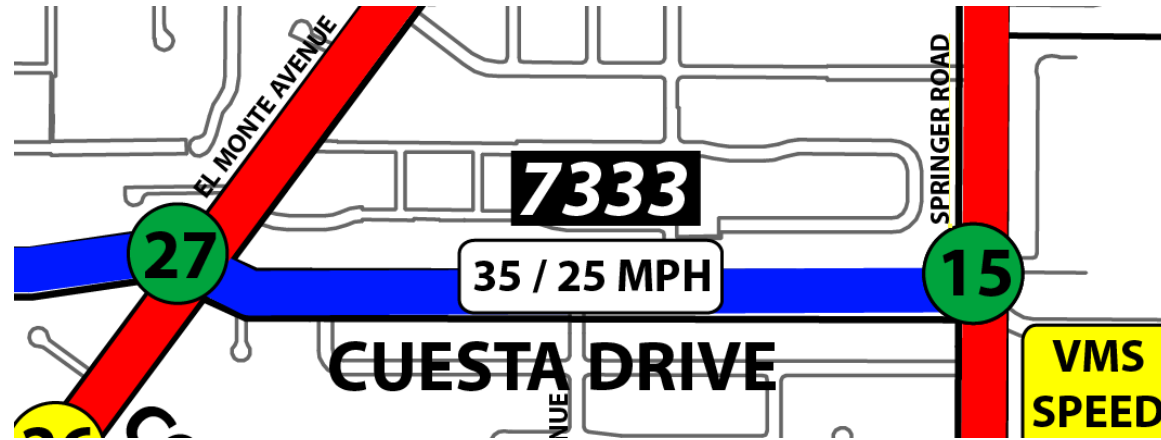

Proposed Traffic Calming

Legend:

- New Standard Roundabout
- New Mini-Roundabout
- ▲ Bulbout (At Intersection)
- Raised Intersection
- Raised Crosswalk / Speed Table
- Surface Treatment / Mound
- Median
- Choker
- ~ Meandering Roadway

*Note: Treated Class II bicycle lanes to be considered along the following Collectors

- Fremont Avenue
- Grant Road
- Springer Road
- El Monte Avenue





4.7 Cuesta Drive: El Monte Avenue to San Antonio Road

Surrounding Land Uses: Between El Monte Avenue and San Antonio Road, Cuesta Drive consists of multi-family residential homes. Los Altos Lutheran Church is located on the northwest corner of Cuesta Drive and El Monte Avenue. West of San Antonio Road, Cuesta Drive merges into First Street, where commercial businesses are located.



Traffic Concerns: Cuesta Drive carries over 5,600 vehicles per day and serves as a connector between the residential neighborhoods east of San Antonio Road and the commercial businesses along First Street and San Antonio Road. Lack of traffic control devices along this stretch of roadway makes this route attractive for east-west through trips between El Monte Avenue and San Antonio Road. Compared to similar collector roadways in Los Altos, 5,600 vpd is a high volume for a collector roadway. Sidewalks and Class III bicycle facilities are currently provided along most of the corridor. The intersection of Gabilan and Cuesta is a crossing for pedestrians accessing the school on nearby El Monte Avenue.

Recommended Tools: The tool selected for this section aims to reduce traffic speed by integrating traffic control devices along Cuesta Drive. These devices may help reduce traffic speeds as well as volume. To successfully slow traffic to within 5 mph of the posted speed limit, the devices should be spaced close together (500 to 800 feet) and should work together as a system.

Mini-Roundabouts were selected for this corridor. Combining two mini-roundabouts, traffic speeds will likely reduce by as much as 10% and traffic volume may reduce by as much as 20 percent. Traffic speeds are significantly reduced through the intersections where roundabouts are placed. This speed reduction is a benefit to pedestrians and bicyclists, and can help to reduce the number and severity of accidents.



Existing Conditions

Legend:

Average Daily Traffic (2007, Source: City)

= Number of Accidents 2000 to 2008 (Where Recorded)

- Class "A" Study Intersection (Traffic Commission Rank 13 - 15)
- Class "B" Study Intersection (Traffic Commission Rank 11 - 12)
- Class "C" Study Intersection (Traffic Commission Rank 7 - 10)
- Class "D" Study Intersection (Traffic Commission Rank 6 or less)

Bike Lanes located on Collectors (Draft Bike Plan 2010)

- Existing Class II
- Existing Class III
- - - Proposed Class III

VMS SPEED LIMIT SIGN VMS = Variable Message Sign (Radar Speed Sign)

/ ## MPH 85th% / Posted Speeds

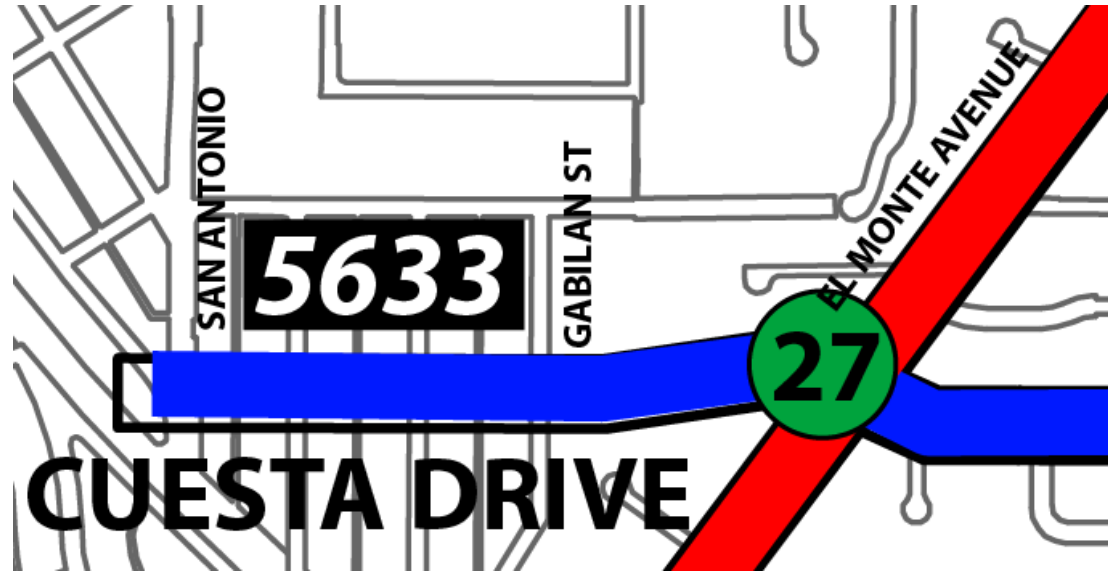

Proposed Traffic Calming

Legend:

- New Standard Roundabout
- New Mini-Roundabout
- ▲ Bulbout (At Intersection)
- Raised Intersection
- Raised Crosswalk / Speed Table
- Surface Treatment / Mound
- Median
- Choker
- ~ Meandering Roadway

**Note: Treated Class II bicycle lanes to be considered along the following Collectors*

- Fremont Avenue
- Grant Road
- Springer Road
- El Monte Avenue

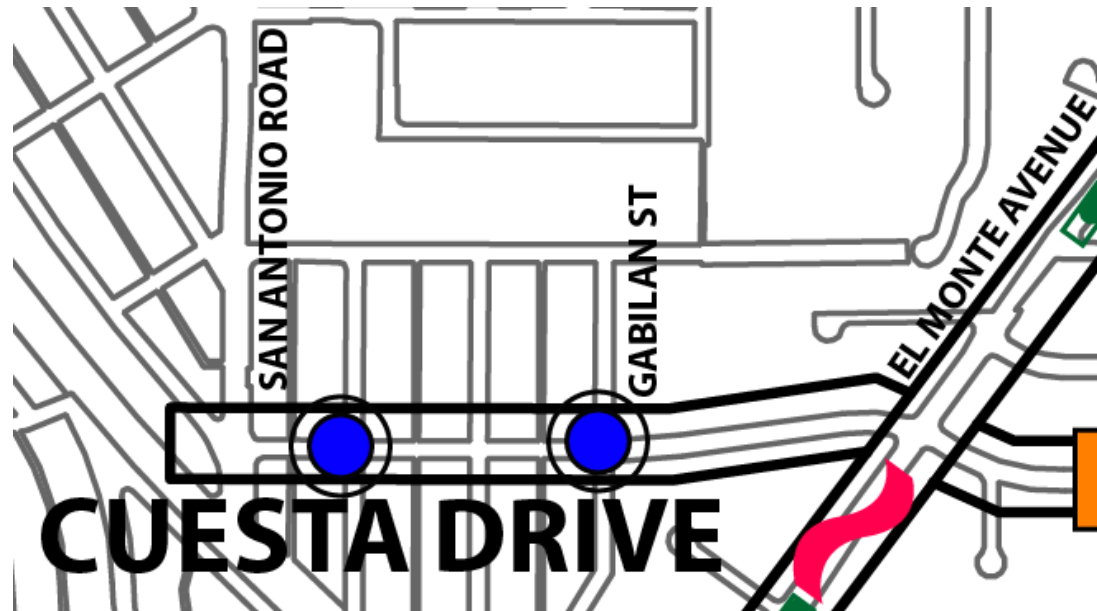



4.8 West Edith Avenue: Foothill Expressway to San Antonio Road

Surrounding Land Uses: Between Foothill Expressway and San Antonio Road, West Edith Avenue consists of single and multi-family residential units and is adjacent to the Los Altos Library.

Traffic Concerns: West Edith Avenue carries over 6,000 vehicles per day. The City has restriped West Edith Avenue with narrower lanes and a Class II bike lane. However, measured traffic speeds continue to exceed the speed limit by 9 mph. As a result the speed limit cannot be enforced by radar. Sidewalks are provided on both sides of the street. Parallel on-street parking is allowed on the eastbound side of the street.



Recommended Tools: The tools selected for this section aim to reduce traffic speeds and compliment the higher density land uses. To conform with the posted speed limit, traffic speeds will need to be reduced by approximately 5-9 mph such that devices should be spaced approximately 400 to 600 feet apart. The physical characteristics of West Edith Avenue are suitable for vertical and horizontal deflection; however careful consideration should be made to limit impacts to parking and bicycle/pedestrian access through this section. Overall the devices selected will work together as a system to potentially reduce through-traffic and maintain consistently lower speeds along the corridor.

As such, the following devices were identified as feasible:

- **Raised Medians:** reduce speeds up to 5% by narrowing the width of the travel lanes
- **Raised Crosswalk:** up to 20% reduction in speed
- **Bulbouts:** reduce pedestrian crossing distance and improve visibility of pedestrians
- **Surface Treatment:** changes pavement surface to draw driver's attention

Working together, these traffic calming devices are anticipated to result in an average 5 to 10 mph decrease in speed along West Edith Avenue, with higher speed reductions at locations with raised crosswalks. Medians, bulbouts, and a raised crosswalk are recommended to visually and physically narrow the roadway to reduce speeds and provide improved crossing conditions for pedestrians. Medians will be constructed to have openings at driveways and will maintain parking and bike lanes.

The intersection of West Edith Avenue and First Street has a high accident rate with approximately 78 accidents reported during the reporting years. This intersection is on the outskirts of the First Street Improvements project and will benefit from improvements identified in that study. To compliment the First Street project and improve visibility of the intersection, surface treatments are recommended around the intersection of West Edith Avenue, Main Street and San Antonio Road to draw drivers' attention to slow down as they enter the commercial end of the corridor.



Existing Conditions

Legend:

Average Daily Traffic (2007, Source: City)

= Number of Accidents 2000 to 2008 (Where Recorded)

- Class "A" Study Intersection (Traffic Commission Rank 13 - 15)
- Class "B" Study Intersection (Traffic Commission Rank 11 - 12)
- Class "C" Study Intersection (Traffic Commission Rank 7 - 10)
- Class "D" Study Intersection (Traffic Commission Rank 6 or less)

Bike Lanes located on Collectors (Draft Bike Plan 2010)

- Existing Class II
- Existing Class III
- Proposed Class III

VMS
SPEED
LIMIT
SIGN VMS = Variable Message Sign (Radar Speed Sign)

/ ## MPH 85th% / Posted Speeds

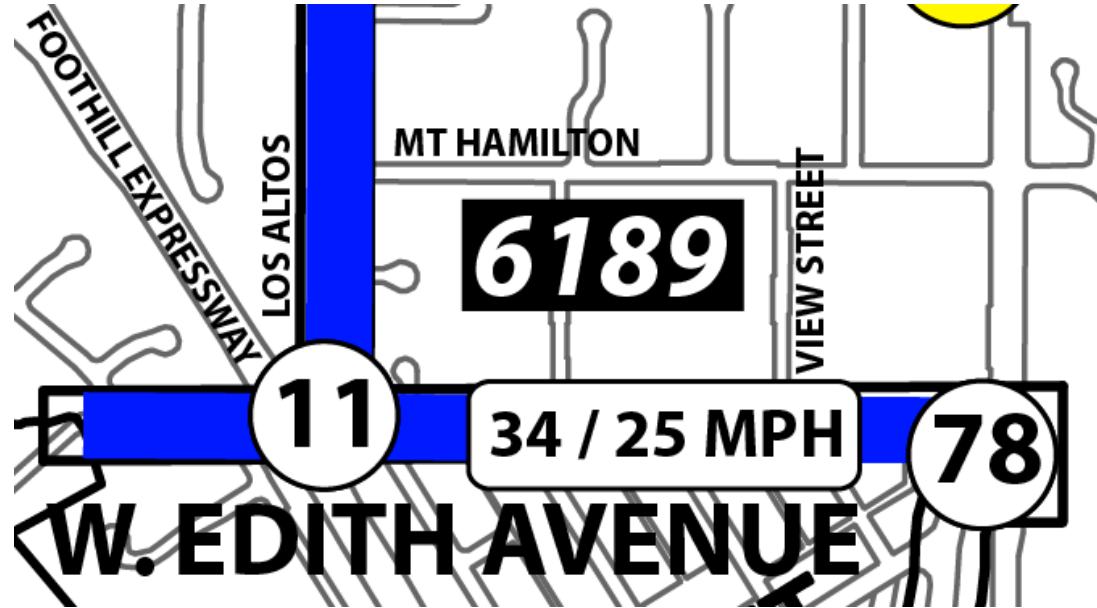

Proposed Traffic Calming

Legend:

- New Standard Roundabout
- New Mini-Roundabout
- ▲ Bulbout (At Intersection)
- Raised Intersection
- Raised Crosswalk / Speed Table
- Surface Treatment / Mound
- Median
- Choker
- Meandering Roadway

*Note: Treated Class II bicycle lanes to be considered along the following Collectors

- Fremont Avenue
- Grant Road
- Springer Road
- El Monte Avenue

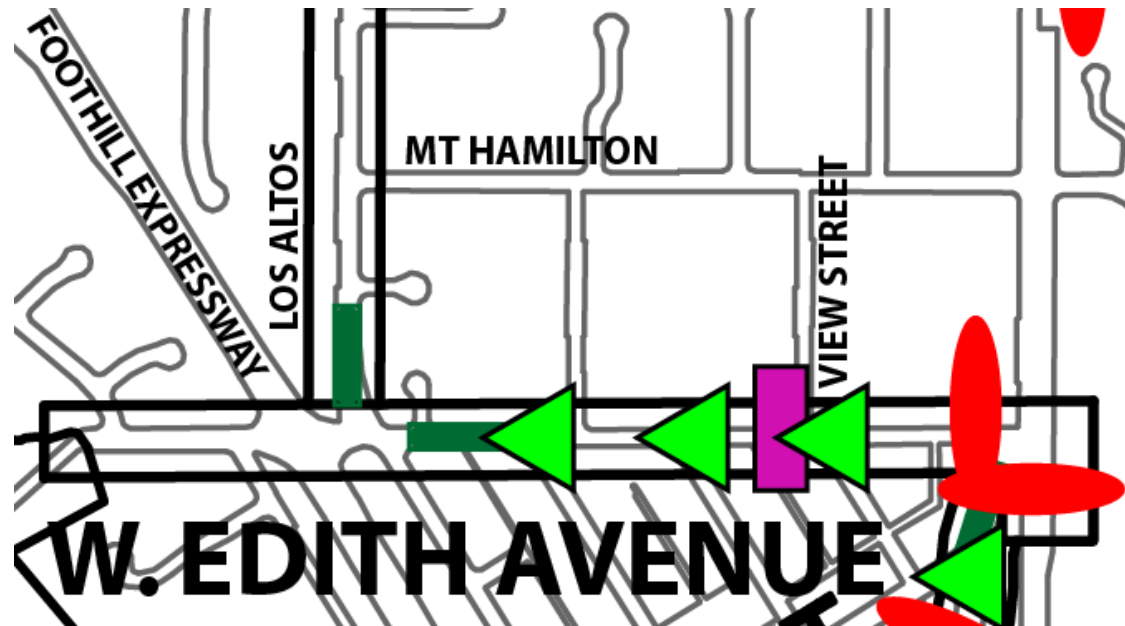



4.9 El Monte Avenue: Foothill Expressway to Springer Road

Surrounding Land Uses: Between Foothill Expressway and Springer Road, El Monte Avenue is fronted by single-family homes. Most homes take direct access from El Monte Avenue and have on-street parking along the frontage of their property. Covington and Almond Elementary Schools take access from El Monte Avenue.



Traffic Concerns: Measured traffic speeds exceed the speed limit by 8 mph, which restricts enforcement by radar. Intermittent sidewalks are provided along El Monte Avenue. Skewed intersections along El Monte present difficulties for pedestrian crossings. Where sidewalks are not provided, pedestrians walk alongside bicycles and passenger vehicles within the existing Class II bicycle lanes.

Recommended Tools: The tools selected for this section aim to reduce traffic speeds to conform with the posted speed limit and improve pedestrian crossing conditions, particularly near the schools. The physical characteristics of the roadway along this stretch of El Monte Avenue and surrounding residential character are suitable for several traffic calming features. To successfully slow traffic to within 5 mph of the posted speed limit, the devices should be spaced close together (500 to 800 feet) and should work together as a system to avoid diversion of traffic to local streets. Mixing the devices or pairing them at key locations will be effective at maintaining consistently lower speeds along the corridor.

As such, the following devices were identified as feasible:

- **Median:** narrows the width of the travel lanes, reducing speeds up to 5 mph.
- **Meandering Roadway:** up to 5% reduction in speed
- **Raised Intersection:** 1 to 10% reduction in speed
- **Mini-Roundabouts:** up to 10% reduction in speed
- **Bulbouts:** reduce pedestrian crossing distance by as much as 16 to 20 feet
- **Roundabout:** up to 10% reduction in speed

In addition to these traffic calming tools, treated Class II bicycle lanes are proposed along El Monte Avenue to improve the bicycling environment. Altogether, the traffic calming devices are anticipated to result in an average 5 to 10 mph decrease in speed along El Monte Avenue. Medians and bulbouts are recommended along this segment, which visually and physically narrow the roadway to reduce speeds and provide improved crossing conditions for pedestrians. Two mini-roundabouts are proposed near the intersection of El Monte Avenue and Hawthorne Avenue to reduce speeds and maintain traffic flow. Concerns were raised that the vegetation and trees at the intersection of El Monte and Springer may obstruct sight distance and should be addressed.



Existing Conditions

Legend:

- #### Average Daily Traffic (2007, Source: City)
- # = Number of Accidents 2000 to 2008 (Where Recorded)
- ⊕ Class "A" Study Intersection (Traffic Commission Rank 13 - 15)
- ⊙ Class "B" Study Intersection (Traffic Commission Rank 11 - 12)
- ⊙ Class "C" Study Intersection (Traffic Commission Rank 7 - 10)
- ⊙ Class "D" Study Intersection (Traffic Commission Rank 6 or less)
- Bike Lanes located on Collectors (Draft Bike Plan 2010)
 - Existing Class II
 - Existing Class III
 - Proposed Class III
- VMS = Variable Message Sign (Radar Speed Sign)
- ## / ## MPH 85th% / Posted Speeds

Proposed Traffic Calming

- Legend:
- New Standard Roundabout
 - New Mini-Roundabout
 - ▲ Bulbout (At Intersection)
 - Raised Intersection
 - Raised Crosswalk / Speed Table
 - Surface Treatment / Mound
 - Median
 - Choker
 - Meandering Roadway
- *Note: Treated Class II bicycle lanes to be considered along the following Collectors
 -Fremont Avenue
 -Grant Road
 -Springer Road
 -El Monte Avenue

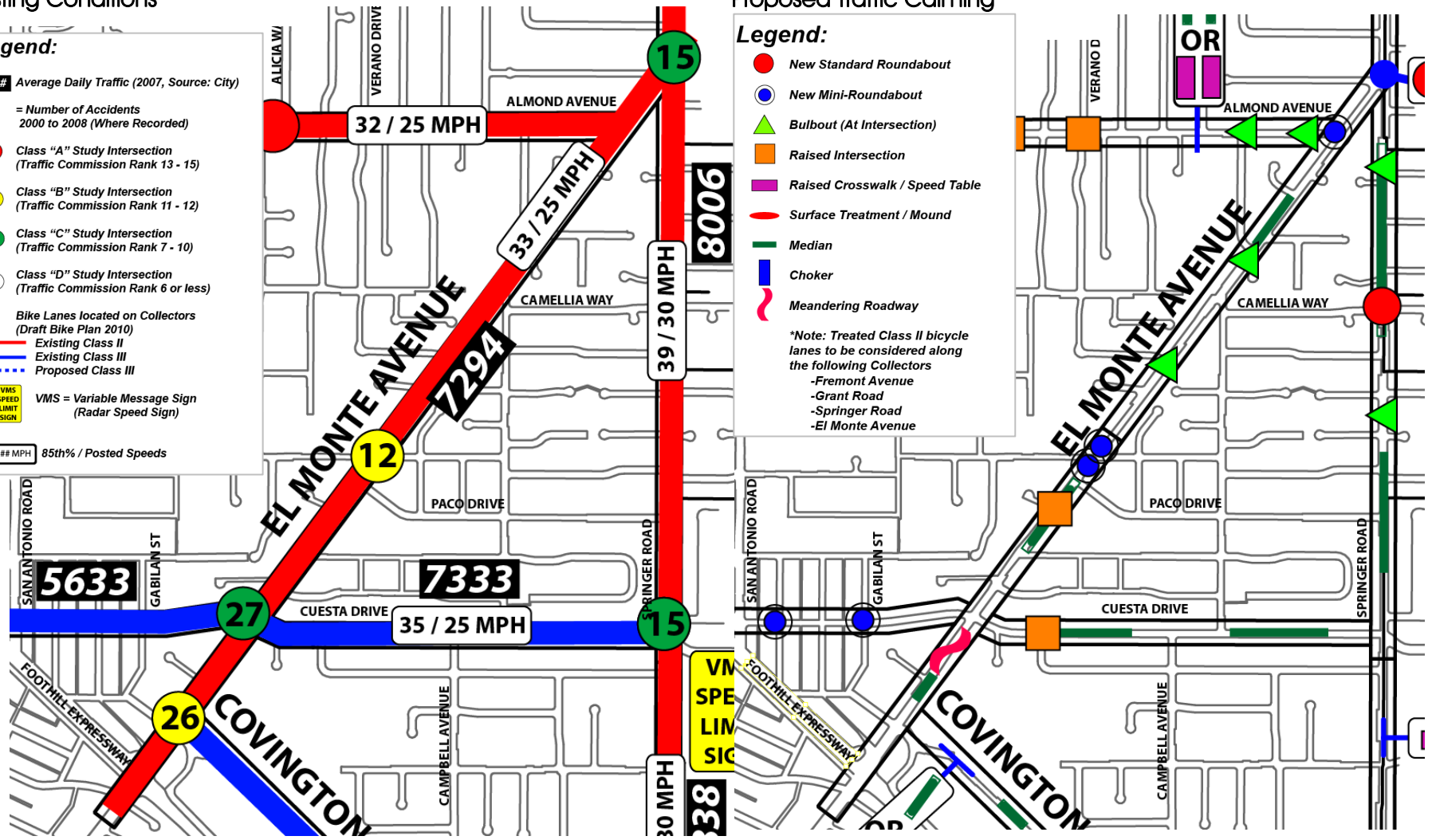



4.10 Fremont Avenue: Springer Road to Miramonte Avenue

Surrounding Land Uses: Between Springer Road and Miramonte Avenue, Fremont Avenue consists of commercial and neighborhood-serving uses, including McKenzie Park. This section of Fremont Avenue runs parallel to the Foothill Expressway.

Traffic Concerns: Measured traffic speeds exceed the speed limit by more than 10 mph, which disallows enforcement by radar. Low traffic on this route suggests most through-traffic travels on the Foothill Expressway. While traffic on Fremont Avenue is local and destined for uses that front Fremont Avenue, this section is prone to speeding as it runs parallel to the Expressway. Commercial uses are scattered and limited to the east side of the street. Low volume combined with long stretches of straight, uninterrupted roadway for motorists, are conducive for speeding. Sidewalks are provided on the east side of the street. Class II bike lanes are provided in both directions through most of this segment of Fremont Avenue.



Recommended Tools: The tools selected for this section take into consideration the existing parking conditions and restricted right-of-way as well as the proximity to the Foothill Expressway. Overall, the tools aim to reduce traffic speeds by as much as 12 mph to conform with the posted speed limit. The low volume and clear line of sight along this stretch of Fremont Avenue is suitable for vertical deflection traffic calming measures. Limited right-of-way and parking make medians and chokers undesirable along this section. To maintain speeds within 5 mph of the posted speed limit, the devices should be spaced close together (500 to 800 feet) and should work together as a system. Mixing the devices or pairing them at key locations will be more effective than the placement of a single device.

As such, the following devices were identified as feasible:

- **Bulbouts:** reduce pedestrian crossing distance by as much as 10 to 15 feet and improve visibility of pedestrians and crosswalks
- **Raised Intersection:** up to 10% reduction in speed
- **Raised Crosswalks:** up to 20% reduction in speed

Working together, the traffic calming devices are anticipated to result in an average 10 mph decrease in speed along Fremont Avenue between Springer Road and Miramonte Avenue. The implementation of raised crosswalks, a raised intersection, and bulbouts would provide an improved pedestrian environment and promote reduced vehicular speeds through the use of vertical deflection. The raised crosswalks are proposed to replace the existing crosswalks on Fremont Avenue.



Existing Conditions

Legend:

Average Daily Traffic (2007, Source: City)

= Number of Accidents 2000 to 2008 (Where Recorded)

- # Class "A" Study Intersection (Traffic Commission Rank 13 - 15)
- # Class "B" Study Intersection (Traffic Commission Rank 11 - 12)
- # Class "C" Study Intersection (Traffic Commission Rank 7 - 10)
- # Class "D" Study Intersection (Traffic Commission Rank 6 or less)

Bike Lanes Located on Collectors (Draft Bike Plan 2010)

- Existing Class II
- Existing Class III
- - - Proposed Class III

VMS
SPEED
LIMIT
SIGN VMS = Variable Message Sign (Radar Speed Sign)

/ ## MPH 85th% / Posted Speeds

Proposed Traffic Calming

Legend:

- New Standard Roundabout
- New Mini-Roundabout
- ▲ Bulbout (At Intersection)
- Raised Intersection
- Raised Crosswalk / Speed Table
- Surface Treatment / Mound
- Median
- Choker
- ~ Meandering Roadway

**Note: Treated Class II bicycle lanes to be considered along the following Collectors*

- Fremont Avenue
- Grant Road
- Springer Road
- El Monte Avenue

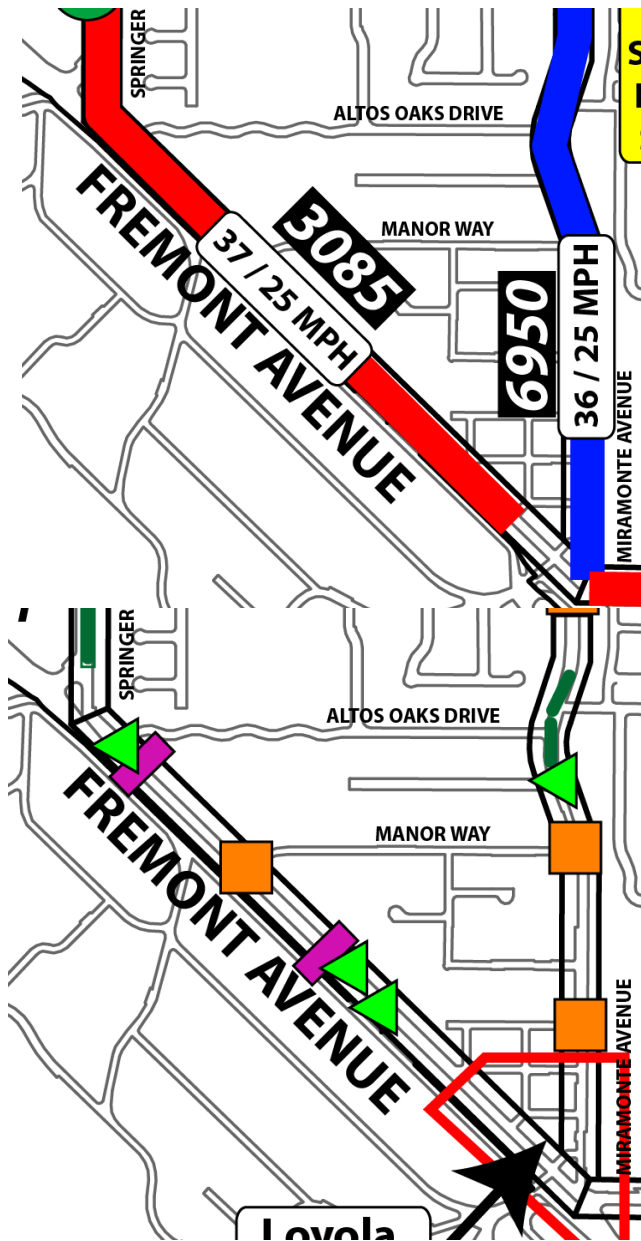



4.11 Fremont Avenue: Miramonte Avenue to Grant Road

Surrounding Land Uses: Between Miramonte Avenue and Grant Road, Fremont Avenue passes through primarily residential neighborhoods with some commercial use towards the intersection of Fremont Avenue and Miramonte Avenue. Marymeade Park is located on Fremont Avenue west of Grant Road.



Traffic Concerns: Measured traffic speeds exceed the speed limit by more than 10 mph, which restricts enforcement by radar. Traffic volumes drop by as much as 11,000 vehicles per day compared to east of Grant Road, but remain high compared to other collector arterials in the City. There are no sidewalks along this portion of Fremont Avenue. Pedestrians commonly walk alongside bicycles and passenger vehicles within the existing 5 foot Class II bicycle lane. The intersection of Fremont Avenue/Miramonte Avenue is identified in the City's priority list of intersection improvements, with over 28 accidents occurring at this all-way stop intersection over the two year period.

Recommended Tools: The tools selected for this section aim to reduce traffic speeds to conform with the posted speed limit and improve visibility of pedestrians at key crossing locations. This narrow stretch of Fremont Avenue is suitable for traffic calming solutions that reduce speeds through vertical deflection measures. Limited right-of-way restricts the ability to use tools such as medians and/or choker.

To successfully slow traffic to within 5 mph of the posted speed limit, the devices should be spaced close together (500 to 800 feet) and should work together as a system. Mixing the devices or pairing them at key locations will be more effective at maintaining consistent speeds along the corridor. The devices selected should also work well with improvements planned for the Loyola Corners Plan.

As such, the following devices were identified as feasible based on existing traffic volume and right-of-way:

- **Raised Crosswalk/Speed Table:** up to 20% reduction in speed
- **Bulbouts:** reduce pedestrian crossing distance and improve visibility of pedestrians
- **Roundabout:** up to 10% reduction in speed, with greater reduction occurring at the intersection

Treated Class II bicycle lanes along Fremont Avenue are also proposed to improve the bicycling environment. Altogether, the traffic calming devices are anticipated to result in an approximately 10 mph decrease in speed, with greater speed reduction through the proposed roundabout at Miramonte Avenue. The implementation of a raised crosswalk, a speed table, and bulbouts would provide improved crossing conditions for pedestrians and promote reduced vehicular speeds through the use of vertical deflection measures. The raised crosswalk is proposed to replace the existing crosswalk on Fremont Avenue.



Existing Conditions

Legend:

- #### Average Daily Traffic (2007, Source: City)
- # = Number of Accidents 2000 to 2008 (Where Recorded)
- Class "A" Study Intersection (Traffic Commission Rank 13 - 15)
- Class "B" Study Intersection (Traffic Commission Rank 11 - 12)
- Class "C" Study Intersection (Traffic Commission Rank 7 - 10)
- Class "D" Study Intersection (Traffic Commission Rank 6 or less)
- Bike Lanes located on Collectors (Draft Bike Plan 2010)
 - Existing Class II
 - Existing Class III
 - Proposed Class III
- VMS SPEED LIMIT SIGN VMS = Variable Message Sign (Radar Speed Sign)
- ## / ## MPH 85th% / Posted Speeds

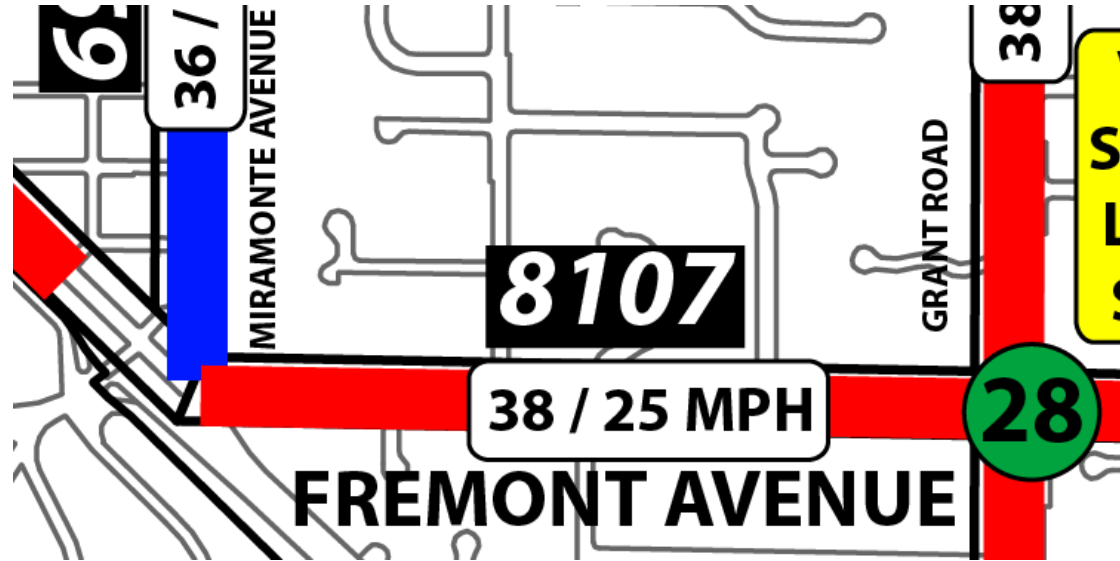

Proposed Traffic Calming

Legend:

- New Standard Roundabout
 - New Mini-Roundabout
 - ▲ Bulbout (At Intersection)
 - Raised Intersection
 - Raised Crosswalk / Speed Table
 - Surface Treatment / Mound
 - Median
 - Choker
 - ~ Meandering Roadway
- *Note: Treated Class II bicycle lanes to be considered along the following Collectors
 -Fremont Avenue
 -Grant Road
 -Springer Road
 -El Monte Avenue

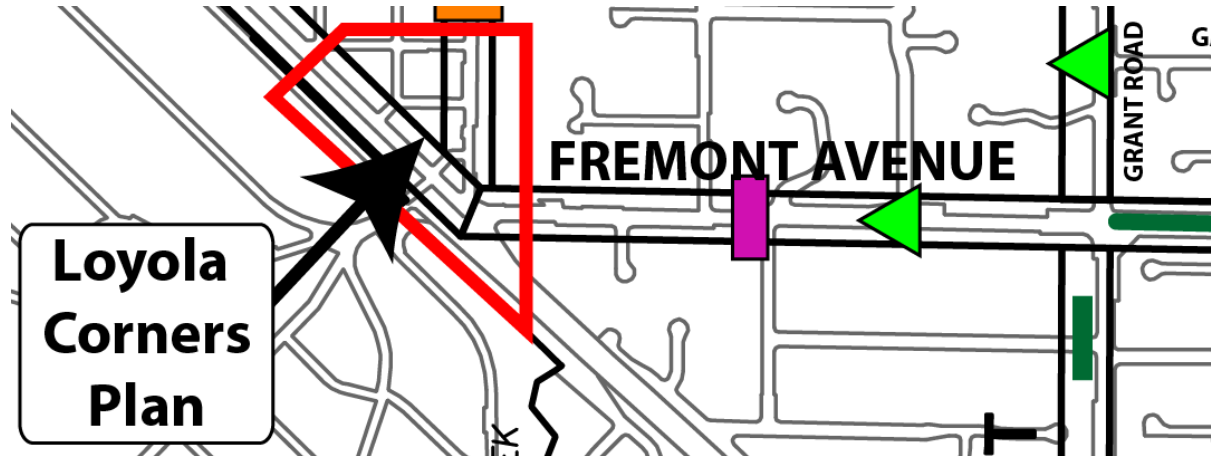



4.12 Fremont Avenue: Grant Road to Eastern City Boundary (Stevens Creek)

Surrounding Land Uses: Between Grant Road and the eastern City Boundary, Fremont Avenue passes through primarily residential neighborhoods with some commercial use near the SR-85 corridor.



Traffic Concerns: Measured traffic speeds exceed the speed limit by more than 9 mph, which restricts enforcement by radar. Traffic volume trends show that there is a high flow of traffic from the SR-85 freeway to Grant Road, such that this route carries less than 50% of local traffic. Most traffic on this route is destined for locations beyond Fremont Avenue. There are no sidewalks along this portion of Fremont Avenue. Pedestrians commonly mix with bicycles and passenger vehicles within the existing 5 foot Class II bicycle lane.

Recommended Tools: To maintain and enforce slower speeds, tools that will reduce traffic speeds along this corridor will need to be reduced by as much as 9 mph to conform with the posted speed limit. Wide roads such as Fremont Avenue allow for a wide array of traffic calming solutions. To successfully slow traffic to within 5 mph of the posted speed limit, the devices should be spaced close together (500 to 800 feet) and should work together as a system to avoid diversion of traffic to local streets. The traffic calming devices installed should maintain consistently lower speeds along the corridor, which is accomplished by mixing the devices or pairing them at key locations.

As such, the following devices were identified as feasible based on existing traffic volumes, available right-of-way, parking, bicycle access and pedestrian activity:

- **Roundabouts:** up to 10% reduction in speed, with greater reduction occurring at the intersection
- **Meandering Streets:** 4 to 5% reduction in speed by shifting traffic across the center of the street
- **Raised Median:** 4 to 5% reduction in speed by narrowing the travel way
- **Bulbouts:** reduce pedestrian crossing distance by as much as 16 to 20 feet and improve visibility of pedestrians and crosswalks

In addition to these traffic calming tools, color treatments to the existing Class II bicycle lanes are proposed to improve the visibility of the bicycle facility and visually narrow the street. Working together, the traffic calming devices are anticipated to result in an average 5 to 10 mph decrease in speed along Fremont Avenue between Grant Avenue and the eastern City Boundary. Greater reductions in speeds will occur at the proposed roundabout with speeds ranging from 15 to 20 mph through the intersection.



Existing Conditions

Legend:

- ### Average Daily Traffic (2007, Source: City)
- # = Number of Accidents 2000 to 2008 (Where Recorded)
- Class "A" Study Intersection (Traffic Commission Rank 13 - 15)
- Class "B" Study Intersection (Traffic Commission Rank 11 - 12)
- Class "C" Study Intersection (Traffic Commission Rank 7 - 10)
- Class "D" Study Intersection (Traffic Commission Rank 6 or less)

Bike Lanes located on Collectors (Draft Bike Plan 2010)

- Existing Class II
- Existing Class III
- Proposed Class III

VMS = Variable Message Sign (Radar Speed Sign)

/ ## MPH 85th% / Posted Speeds

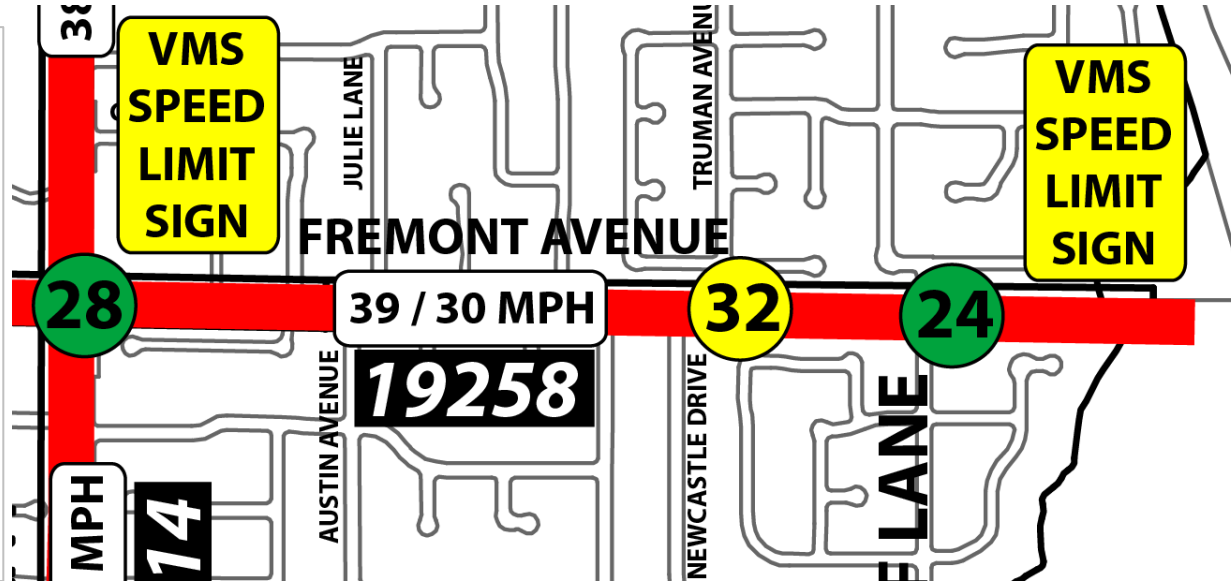

Proposed Traffic Calming

Legend:

- New Standard Roundabout
- New Mini-Roundabout
- ▲ Bulbout (At Intersection)
- Raised Intersection
- Raised Crosswalk / Speed Table
- Surface Treatment / Mound
- Median
- Choker
- ~ Meandering Roadway

**Note: Treated Class II bicycle lanes to be considered along the following Collectors*

- Fremont Avenue
- Grant Road
- Springer Road
- El Monte Avenue

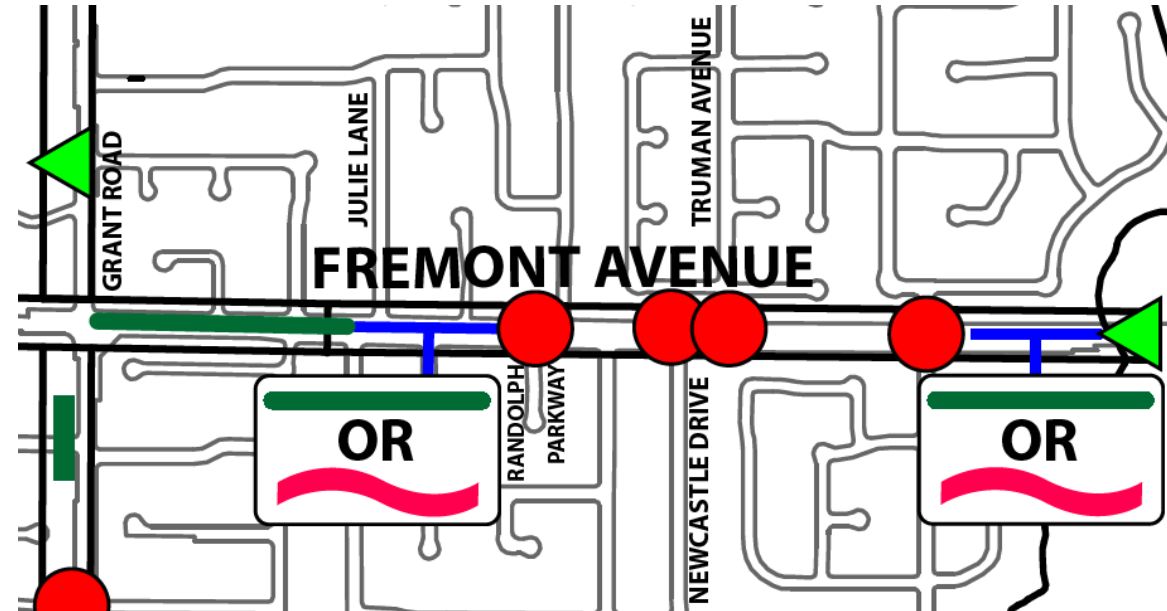



4.13 Grant Road: Foothill Expressway to Fremont Avenue

Surrounding Land Uses: Between the Foothill Expressway and Fremont Avenue, Grant Road consists of primarily residential with some commercial and community uses, including churches.

Traffic Concerns: This segment of Grant Road carries over 10,000 vehicles per day and serves as a connection between the surrounding residential neighborhoods and Montclair Elementary School, located south of the Foothill Expressway along St. Joseph Avenue. Measured traffic speeds on Grant Road exceed the speed limit by 13 mph. Both traffic speed and traffic volume are significantly higher than other collector roadways in the City. To address the higher volumes and speeds, left turn pockets are provided at key intersections and the roadway is divided by a striped center median. Despite the high volume and speeds, sidewalks provided along Grant Road are intermittent. Where sidewalks are not provided, pedestrians walk alongside bicycles and passenger vehicles within the existing Class II bicycle lanes.



Recommended Tools: The tools selected for this section aim to reduce traffic speeds by as much as 13 mph to conform with the posted speed limit. Significant modifications will be necessary to reduce the speeds along this road to conform with the posted speed limit.

As such, the following devices were identified as feasible:

- **Median:** narrows the width of the travel lanes
- **Raised Crosswalk:** up to 10% reduction in speed
- **Roundabout:** up to 10% reduction in speed

The most successful tools for reducing speed are the speed table/raised crosswalk and roundabout. The vertical deflection of the raised crosswalk reduces speeds at the device by as much as 20%. Similarly, speeds through a roundabout typically range from 15 to 20 mph. To successfully slow traffic and maintain consistently lower speeds along the corridor (within 5 mph of the posted speed limit), devices should be placed 500 to 700 feet apart.

Working together, these traffic calming devices are anticipated to result in an average 10% decrease in traffic speed along Grant Road. The median proposed near Richardson Avenue will visually and physically narrow the roadway to help reduce speeds and will provide improved crossing conditions for pedestrians. A raised crosswalk is recommended along Grant Road near Morton Avenue which would replace the existing crosswalk, and provide access to St. Simon Catholic Church and VTA bus stops.



Existing Conditions

Proposed Traffic Calming

Legend:

- ### Average Daily Traffic (2007, Source: City)
- # = Number of Accidents 2000 to 2008 (Where Recorded)
- # Class "A" Study Intersection (Traffic Commission Rank 13 - 15)
- # Class "B" Study Intersection (Traffic Commission Rank 11 - 12)
- # Class "C" Study Intersection (Traffic Commission Rank 7 - 10)
- # Class "D" Study Intersection (Traffic Commission Rank 6 or less)
- Bike Lanes located on Collectors (Draft Bike Plan 2010)
 - Existing Class II
 - Existing Class III
 - Proposed Class III
- VMS SPEED LIMIT SIGN VMS = Variable Message Sign (Radar Speed Sign)
- ## / ## MPH 85th% / Posted Speeds

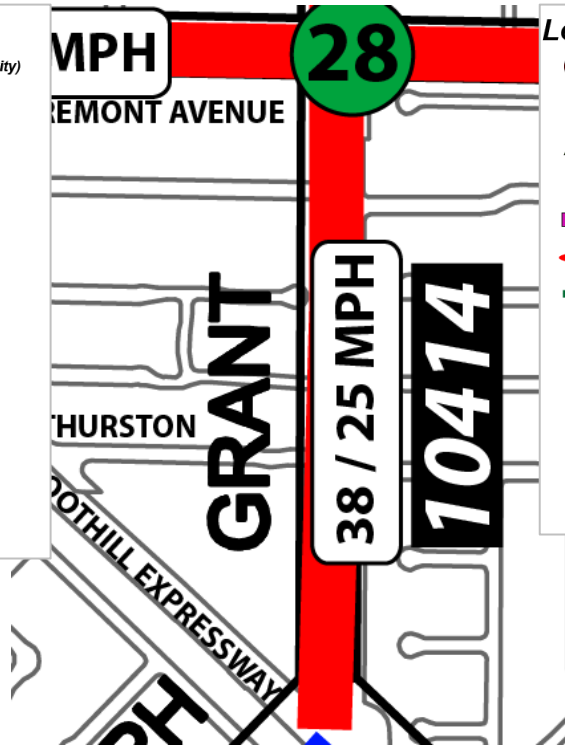

Legend:

- New Standard Roundabout
 - New Mini-Roundabout
 - ▲ Bulbout (At Intersection)
 - Raised Intersection
 - Raised Crosswalk / Speed Table
 - Surface Treatment / Mound
 - Median
 - Choker
 - ~ Meandering Roadway
- *Note: Treated Class II bicycle lanes to be considered along the following Collectors
 -Fremont Avenue
 -Grant Road
 -Springer Road
 -El Monte Avenue

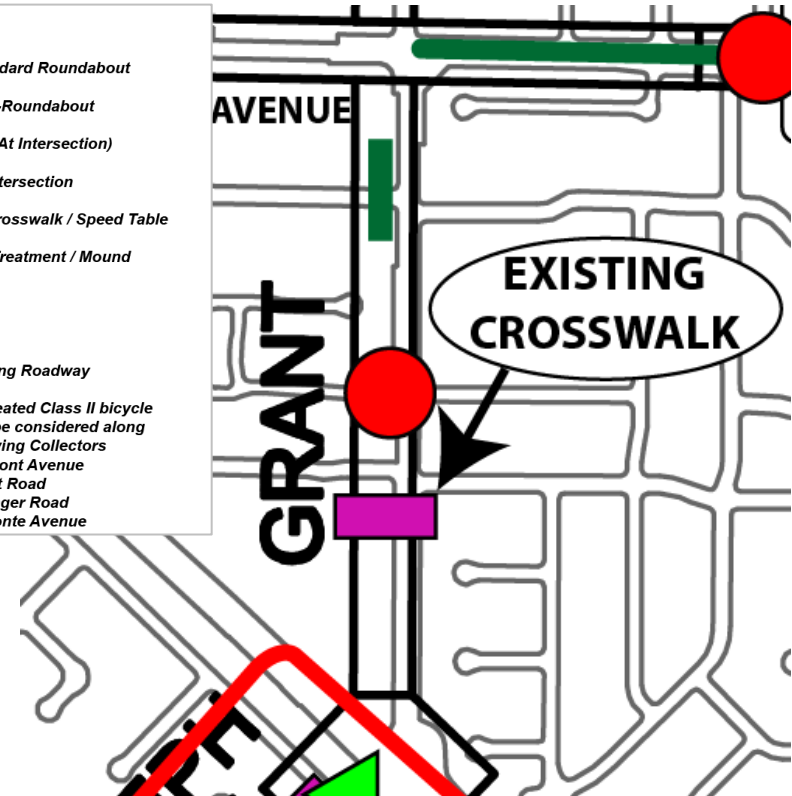



4.14 Grant Road: Fremont Avenue to Covington Road

Surrounding Land Uses: Between Fremont Avenue and Covington Road, Grant Road consists of primarily residential and community uses, including churches and schools.

Traffic Concerns: This segment of Grant Road carries over 20,000 vehicles per day, and serves as a key north-south connector from SR-85 to the City of Mountain View. Pedestrians utilize this segment to travel to the Blach School near the Grant and Covington Road intersection. The City has identified the intersections at Grant/Covington and Grant/Fremont on the list of priority intersections. Measured traffic speeds exceed the speed limit by 13 mph. Enforcement by radar is not permitted as the difference in measured to posted speed is more than 5 mph. VMS speed limit signs and pavement markings identifying the 25 mph speed limit are currently posted along the street. These devices are passive and have been moderately effective in educating drivers of the speed limit. Intermittent sidewalks are provided along Grant Road. Where sidewalks are not provided, pedestrians walk alongside bicycles and passenger vehicles within the existing Class II and Class III bicycle facilities.



Recommended Tools: To reduce the speeds along this segment, significant changes to the cross-section and intersection traffic controls are necessary. The most effective tools at reducing traffic speeds are speed tables/raised crosswalks and roundabouts. Both devices can effectively reduce traffic speeds by 20% or more at the device. To successfully maintain consistently lower speeds along the corridor, devices will need to be placed 500 to 700 feet apart and will need to vary between horizontal and vertical devices. Mixing the devices or pairing them at key locations will be more effective than the placement of a single device.

As such, the following devices were identified as feasible:

- **Bulbouts:** reduce pedestrian crossing distance by as much as 10 to 15 feet and improve visibility of pedestrians and crosswalks
- **Raised Intersection:** 1 to 10% reduction in speed
- **Roundabout:** up to 10% reduction in speed

In addition to these traffic calming measures, treated Class II bicycle lanes along Grant Road are proposed to improve the bicycling environment. The traffic calming devices are anticipated to result in an up to a 10 mph decrease in speed along Grant Road. The implementation of bulbouts, a raised intersection, and a roundabout would provide an improved pedestrian environment and promote reduced vehicular speeds through the use of vertical deflection.



Existing Conditions

Legend:

- ### Average Daily Traffic (2007, Source: City)
- # = Number of Accidents 2000 to 2008 (Where Recorded)
- ⊕ Class "A" Study Intersection (Traffic Commission Rank 13 - 15)
- ⊙ Class "B" Study Intersection (Traffic Commission Rank 11 - 12)
- ⊕ Class "C" Study Intersection (Traffic Commission Rank 7 - 10)
- ⊙ Class "D" Study Intersection (Traffic Commission Rank 6 or less)
- Bike Lanes located on Collectors (Draft Bike Plan 2010)
 - Existing Class II
 - Existing Class III
 - Proposed Class III
- VMS = Variable Message Sign (Radar Speed Sign)
- ## / ## MPH 85th% / Posted Speeds

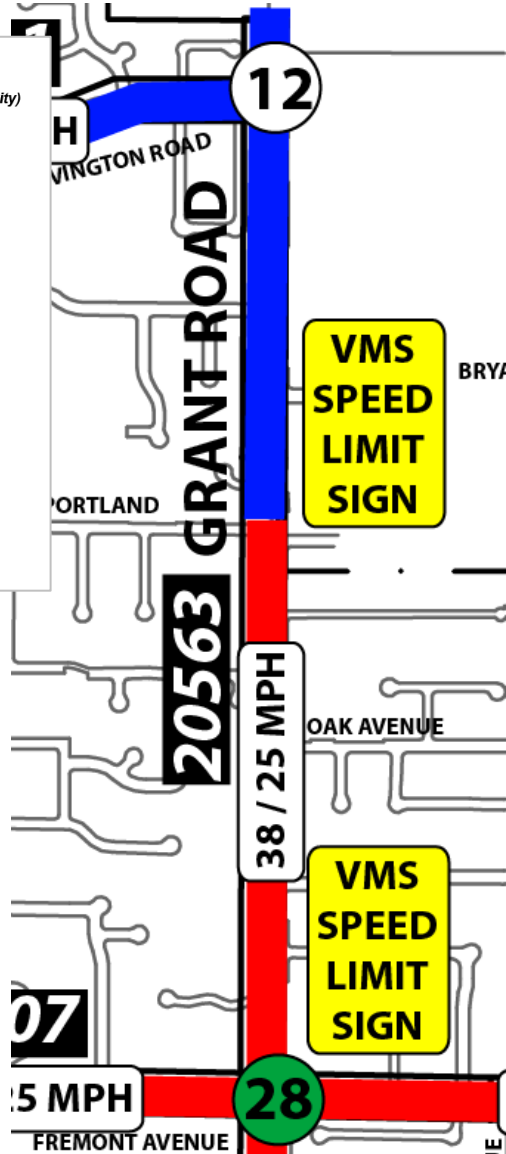

Proposed Traffic Calming

Legend:

- New Standard Roundabout
 - New Mini-Roundabout
 - Bulbout (At Intersection)
 - Raised Intersection
 - Raised Crosswalk / Speed Table
 - Surface Treatment / Mound
 - Median
 - Choker
 - Meandering Roadway
- *Note: Treated Class II bicycle lanes to be considered along the following Collectors*
- Fremont Avenue
 - Grant Road
 - Springer Road
 - El Monte Avenue

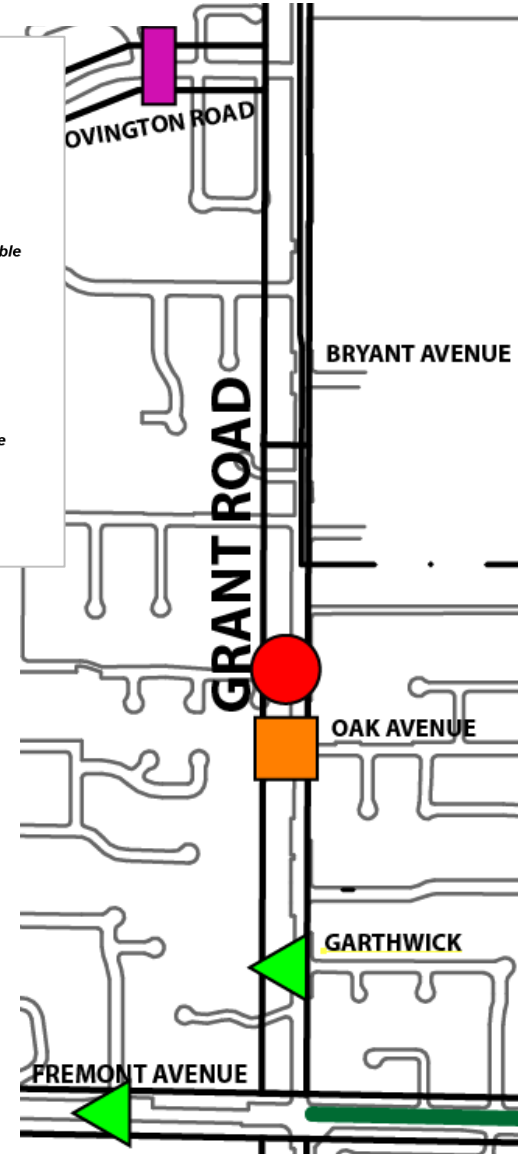



4.15 Los Altos Avenue: West Edith Avenue to Pine Lane

Surrounding Land Uses: Between West Edith Avenue and Pine Lane, Los Altos Avenue is a two-lane roadway that connects to several surrounding residential neighborhoods.

Traffic Concerns: Measured traffic speeds exceed the speed limit by more than 5 mph, which restricts enforcement by radar. Traffic volumes on Los Altos Avenue are appropriate for both horizontal and vertical tools to break up the long, straight section that extends from West Edith Avenue to Pine Lane. Intermittent sidewalks are provided along Los Altos Avenue. Where sidewalks are not provided, pedestrians walk alongside bicycles and passenger vehicles within the existing Class III bicycle facilities. On-street parking is allowed in many sections of Los Altos Avenue.



Recommended Tools: The tools selected for this section aim to reduce traffic speeds to conform to posted speed limits and improve pedestrian visibility at marked crosswalks. The wide roadway along this stretch of Los Altos Avenue and surrounding residential character are suitable for several traffic calming features, including vertical deflection measures that reduce speeds and horizontal deflections that reduce the pedestrian crossing distance. To successfully slow traffic to within 5 mph of the posted speed limit, the devices should be spaced close together (500 to 800 feet) and should work together as a system to maintain a constant speed along the corridor. Mixing the devices or pairing them at key locations will be more effective than the placement of a single device. The devices should be placed to minimize impacts to resident access and parking, but should remain within the recommended spacing of 500 to 800 feet.

As such, the following devices were identified as feasible based on existing right-of-way, speed and volume along the corridor:

- **Median:** reduces speeds 4 to 5% by narrowing the width of the travel lanes
- **Bulbouts:** reduce pedestrian crossing distance by as much as 10 feet
- **Raised Intersection:** up to 10% reduction in speed

Working together, the traffic calming devices are anticipated to result in an average 5 to 10 mph decrease in speed along Los Altos Avenue between West Edith Avenue and Pine Lane. Bulbouts improve pedestrian crossing conditions by reducing the crossing distance. Therefore, bulbouts have been identified at two intersections. The medians are recommended to be placed near the major intersections to promote lower speeds along the segment. The combination of bulbouts with the medians decreases the total width of the road at intersections, resulting in a significant reduction in speed. The combination of traffic calming devices would reduce traffic speeds along the segment and create a more pedestrian-friendly street.



Existing Conditions

Legend:

- ### Average Daily Traffic (2007, Source: City)
- # = Number of Accidents 2000 to 2008 (Where Recorded)
- Class "A" Study Intersection (Traffic Commission Rank 13 - 15)
- Class "B" Study Intersection (Traffic Commission Rank 11 - 12)
- Class "C" Study Intersection (Traffic Commission Rank 7 - 10)
- Class "D" Study Intersection (Traffic Commission Rank 6 or less)
- Bike Lanes located on Collectors (Draft Bike Plan 2010)
 - Existing Class II
 - Existing Class III
 - Proposed Class III
- VMS = Variable Message Sign (Radar Speed Sign)
- ## / ## MPH 85th% / Posted Speeds

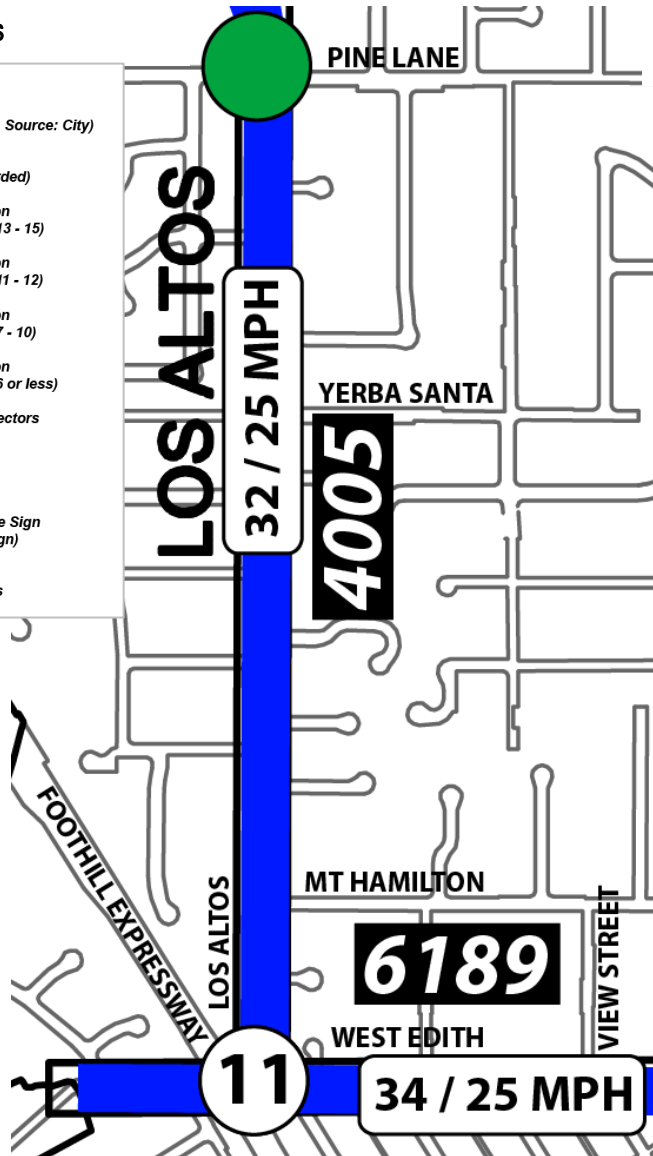

Proposed Traffic Calming

Legend:

- New Standard Roundabout
 - New Mini-Roundabout
 - ▲ Bulbout (At Intersection)
 - Raised Intersection
 - Raised Crosswalk / Speed Table
 - Surface Treatment / Mound
 - Median
 - Choker
 - ~ Meandering Roadway
- *Note: Treated Class II bicycle lanes to be considered along the following Collectors
 -Fremont Avenue
 -Grant Road
 -Springer Road
 -El Monte Avenue

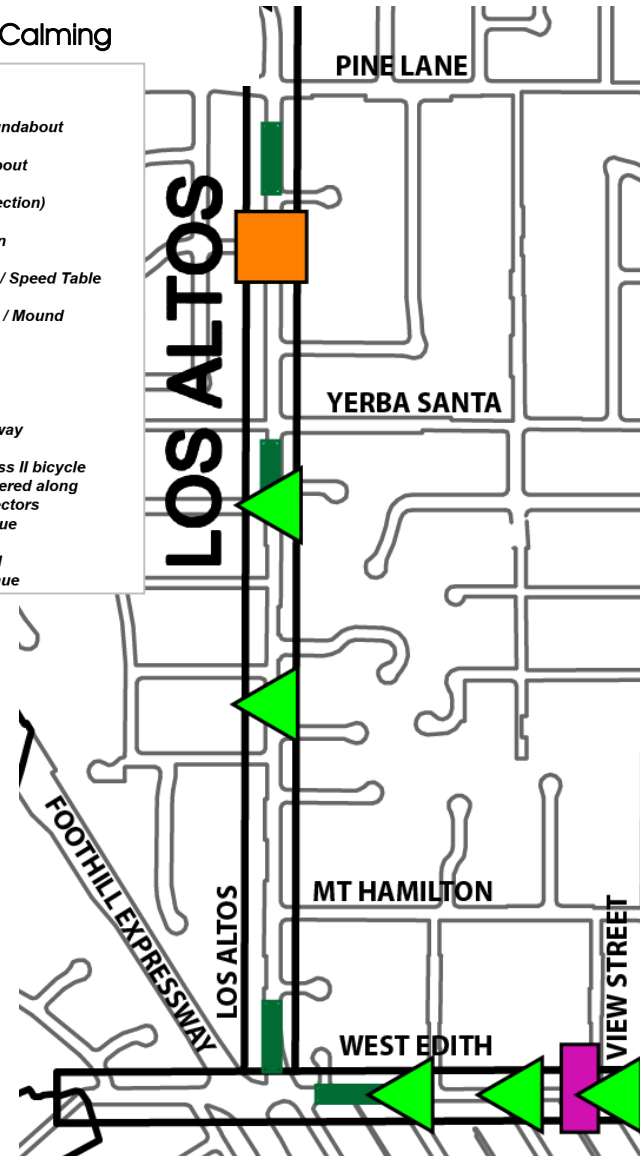



4.16 Los Altos Avenue: Pine Lane to City Boundary (El Camino Real)

Surrounding Land Uses: Between Pine Lane and the City Boundary (El Camino Real), Los Altos Avenue is a two-lane roadway that consists of primarily residential neighborhoods, commercial uses towards El Camino Real and community-serving uses.



Traffic Concerns: Traffic through the area consists of local and non-local trips, as Los Altos Avenue provides north-south access between the residential neighborhoods, commercial uses along El Camino Real, and other neighborhoods and commercial uses south of Pine Lane. Existing travel lanes are wide (12' +) and could be narrowed. Sidewalks, and Class III bike facilities are provided along this segment of Los Altos Avenue.

Recommended Tools: The tools selected for this section aim to reduce traffic speeds to conform with the posted speed limit and improve pedestrian crossing conditions. Los Altos Avenue is suitable for both vertical and horizontal deflection. To successfully slow traffic to within 5 mph of the posted speed limit, the devices should be spaced close together (500 to 800 feet). Mixing the devices such that they work together as a system will maintain consistently lower speeds along the corridor.

Working within the curb-to curb width of Los Altos Avenue, the following devices were identified as feasible:

- **Medians:** narrow the street and reduces the width of the travel lanes, resulting in a 4 to 5% reduction in speed
- **Raised Crosswalks:** up to 20% reduction in speed
- **Bulbouts:** reduce pedestrian crossing distance by as much as 16 to 20 feet
- **Surface Treatment/Mound:** changes pavement surface to draw drivers' attention

The traffic calming devices identified are anticipated to result in an average 5 to 10 mph decrease in speed along Los Altos Avenue between Pine Lane and El Camino Real. Alternating the medians and bulbouts result in a shift in traffic across the centerline of the road. This shift in traffic creates a more attractive and interrupted line of sight. As a result, drivers are more aware and tend to reduce speed if devices are placed within the appropriate distances. To further reduce speeds, raised crosswalks are proposed at existing crosswalk locations. The combination of traffic calming devices would reduce speeds and improve the pedestrian environment, particularly near the Santa Rita School. Surface treatments are recommended with bulbouts at the intersection of Los Altos and West Portola Avenue, which provides access to Egan Junior High School.



Existing Conditions

Legend:

- ### Average Daily Traffic (2007, Source: City)
- # = Number of Accidents 2000 to 2008 (Where Recorded)
- # Class "A" Study Intersection (Traffic Commission Rank 13 - 15)
- # Class "B" Study Intersection (Traffic Commission Rank 11 - 12)
- # Class "C" Study Intersection (Traffic Commission Rank 7 - 10)
- # Class "D" Study Intersection (Traffic Commission Rank 6 or less)
- Bike Lanes located on Collectors (Draft Bike Plan 2010)
 - Existing Class II
 - Existing Class III
 - Proposed Class III
- VMS SPEED LIMIT SIGN VMS = Variable Message Sign (Radar Speed Sign)
- ## / ## MPH 85th% / Posted Speeds

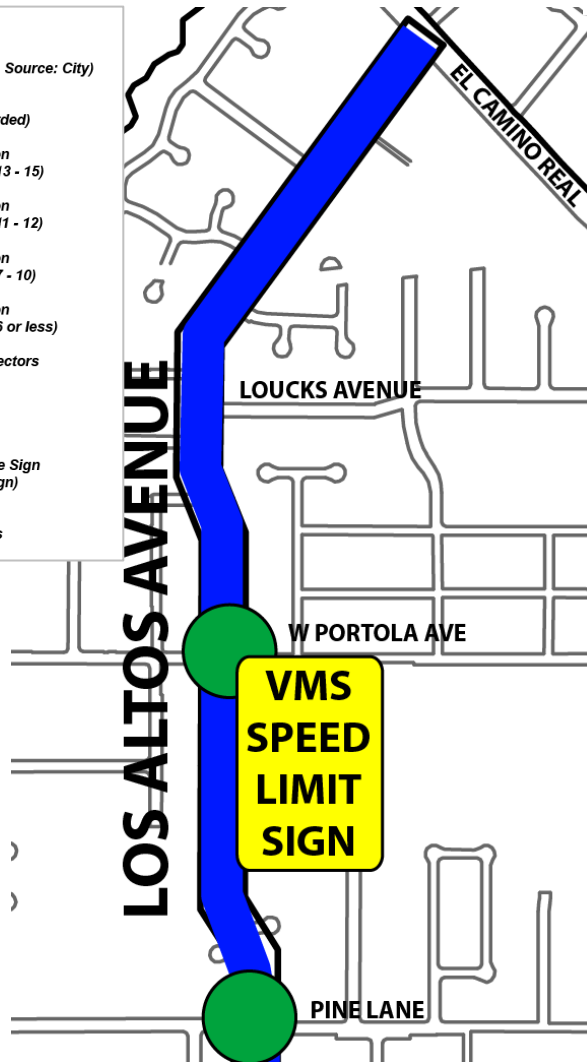

Proposed Traffic Calming

Legend:

- New Standard Roundabout
 - New Mini-Roundabout
 - ▲ Bulbout (At Intersection)
 - Raised Intersection
 - Raised Crosswalk / Speed Table
 - Surface Treatment / Mound
 - Median
 - Choker
 - ~ Meandering Roadway
- *Note: Treated Class II bicycle lanes to be considered along the following Collectors
 -Fremont Avenue
 -Grant Road
 -Springer Road
 -El Monte Avenue

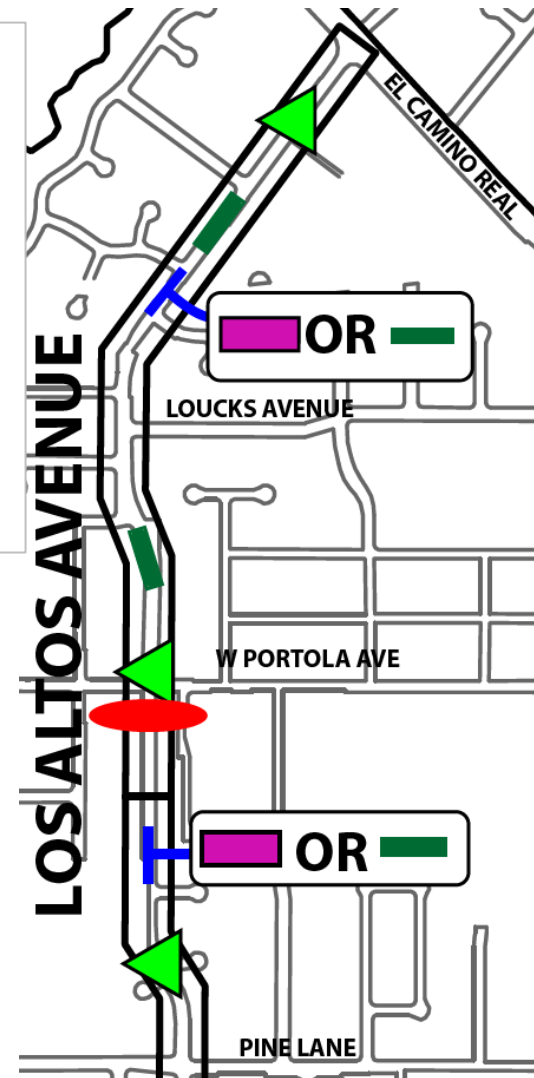



4.17 Main Street: Foothill Expressway to San Antonio Road

Surrounding Land Uses: Between Foothill Expressway to San Antonio Road, Main Street travels through downtown Los Altos consisting of commercial land uses.



Traffic Concerns: Main Street carries over 4,800 vehicles per day. Sidewalks are currently provided on both sides of the street but there are no bicycle facilities. Each intersection is two-way stop controlled and includes pedestrian crosswalks. Both sides of Main Street include diagonal and/or parallel parking.

Recommended Tools: The tools selected for this section aim to reduce traffic speeds to conform to the posted speed limit and improve the pedestrian environment, particularly for pedestrians shopping and working at the downtown businesses. The characteristics of Main Street are suitable for vertical and horizontal deflection traffic calming measures. To successfully slow traffic to the desired speed range (25-30 mph) the devices should be spaced close together (500 to 600 feet) and should work together as a system to avoid diversion of traffic to local streets and to maintain consistently lower speeds along the corridor. Considerations should be made to minimize impacts to parking and business driveways.

As such, the following devices were identified as feasible:

- **Bulbouts:** reduces pedestrian crossing distance by as much as 10 to 15 feet and improves visibility of pedestrians and crosswalks
- **Mounds:** changes pavement surface to draw drivers' attention
- **Medians:** narrow the street and reduces the width of the travel lanes, resulting in a 4 to 5% reduction in speed

Working together, the traffic calming devices are anticipated to result in an approximately 5 mph decrease in speed and an improved pedestrian environment along Main Street. Mounds are proposed at the intersection of Main Street and First Street and at the existing pedestrian crosswalk located mid-block on Main Street between State Street and Third Street. A bulbout is proposed at the intersection of Main Street and State Street to slow speeds and to distinguish the east entrance to the downtown district.



Existing Conditions

Legend:

Average Daily Traffic (2007, Source: City)

= Number of Accidents 2000 to 2008 (Where Recorded)

- Class "A" Study Intersection (Traffic Commission Rank 13 - 15)
- Class "B" Study Intersection (Traffic Commission Rank 11 - 12)
- Class "C" Study Intersection (Traffic Commission Rank 7 - 10)
- Class "D" Study Intersection (Traffic Commission Rank 6 or less)

Bike Lanes located on Collectors (Draft Bike Plan 2010)

- Existing Class II
- Existing Class III
- - - Proposed Class III

VMS
SPEED
LIMIT
SIGN VMS = Variable Message Sign (Radar Speed Sign)

/ ## MPH 85th% / Posted Speeds

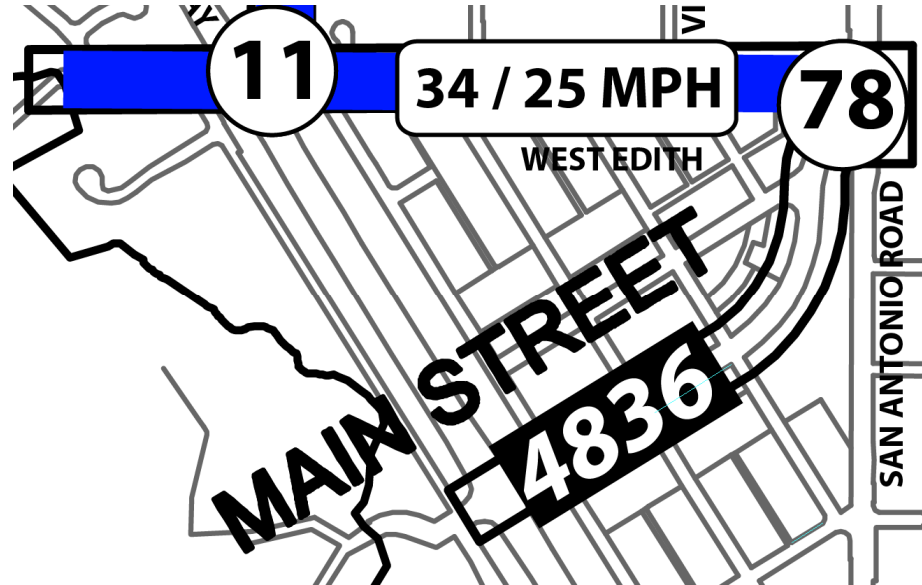

Proposed Traffic Calming

Legend:

- New Standard Roundabout
- New Mini-Roundabout
- ▲ Bulbout (At Intersection)
- Raised Intersection
- Raised Crosswalk / Speed Table
- Surface Treatment / Mound
- Median
- Choker
- ~ Meandering Roadway

*Note: Treated Class II bicycle lanes to be considered along the following Collectors

- Fremont Avenue
- Grant Road
- Springer Road
- El Monte Avenue





4.18 Miramonte Avenue: Fremont Avenue to City Boundary (Alegre Avenue)

Surrounding Land Uses: Between Fremont Avenue and the City Boundary (Alegre Avenue), Miramonte Avenue is primarily residential with some commercial uses. Heritage Oaks Park is also located along Miramonte Avenue at Portland Avenue.



Traffic Concerns: Measured traffic speeds exceed the speed limit by 7 mph, which restricts enforcement by radar. Intermittent sidewalks and Class III bicycle facilities are provided along Miramonte Avenue. Where sidewalks are not provided, pedestrians walk alongside bicycles and passenger vehicles along the shoulder of the road. Vehicles are allowed to park within the shoulder area for much of Miramonte Avenue.

Recommended Tools: The tools selected for this section aim to reduce traffic speeds to conform with the posted speed limit, while remaining within the existing right-of-way. Miramonte Avenue is suitable for both vertical and horizontal deflection traffic calming measures based on the cross-section of the road and the existing volume. To successfully slow traffic to the desired speed range (25-30 mph) the devices should be spaced close together (500 to 800 feet) and should work together as a system to maintain consistently lower speeds along the corridor. The devices selected should also work well with improvements planned for the Loyola Corners Plan.

As such, the following devices were identified as feasible:

- **Raised Medians:** reduces speeds up to 5% by narrowing the width of the travel lanes
- **Raised Intersection:** 1 to 10% reduction in speed
- **Mini-Roundabout:** up to 20% reduction in speed
- **Bulbouts:** reduce pedestrian crossing distance and improve visibility of pedestrians and crosswalks

Working together, these traffic calming devices are anticipated to result in an average 5 to 10 mph decrease in speed along Miramonte Avenue. Collectively these devices aim to break up the long, straight line of sight that currently influences speeds along the corridor. Medians and bulbouts are recommended along this segment, which visually and physically narrow the roadway. Combined, the raised median and bulbouts decrease crossing distances for pedestrians at intersections and provide for a refuge area in the middle of the street. The combination also significantly narrows down the travel area through the intersection resulting in significant reductions in speed approaching the intersection, which improves pedestrian safety. A mini-roundabout is proposed that would effectively control speed at and maintain traffic flow at an intersection along the corridor.



Existing Conditions

Legend:

- ### Average Daily Traffic (2007, Source: City)
- # = Number of Accidents 2000 to 2008 (Where Recorded)
- Class "A" Study Intersection (Traffic Commission Rank 13 - 15)
- Class "B" Study Intersection (Traffic Commission Rank 11 - 12)
- Class "C" Study Intersection (Traffic Commission Rank 7 - 10)
- Class "D" Study Intersection (Traffic Commission Rank 6 or less)
- Bike Lanes located on Collectors (Draft Bike Plan 2010)
 - Existing Class II
 - Existing Class III
 - Proposed Class III
- VMS SPEED LIMIT SIGN VMS = Variable Message Sign (Radar Speed Sign)
- # / # MPH 85th% / Posted Speeds

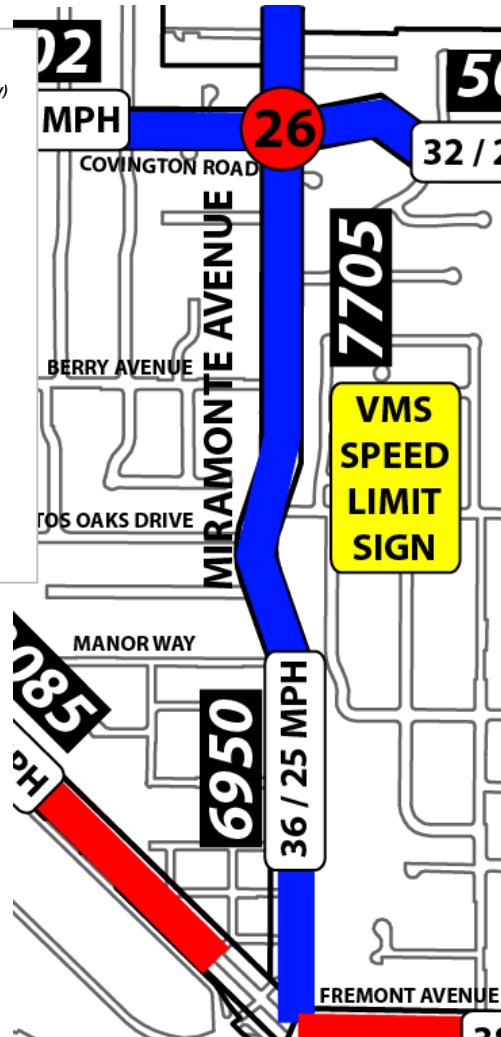

Proposed Traffic Calming

Legend:

- New Standard Roundabout
 - New Mini-Roundabout
 - ▲ Bulbout (At Intersection)
 - Raised Intersection
 - Raised Crosswalk / Speed Table
 - Surface Treatment / Mound
 - Median
 - Choker
 - Meandering Roadway
- *Note: Treated Class II bicycle lanes to be considered along the following Collectors*
- Fremont Avenue
 - Grant Road
 - Springer Road
 - El Monte Avenue

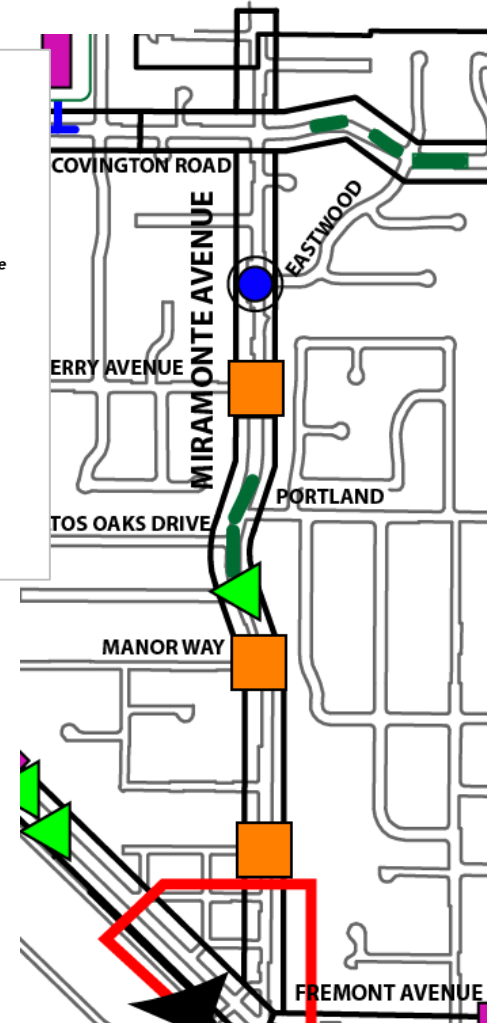



4.19 Springer Road: Foothill Expressway to Cuesta Drive

Surrounding Land Uses: Between Foothill Expressway and Cuesta Drive, Springer Road is a two-lane roadway that consists of primarily residential neighborhoods with commercial uses around the intersection of Springer Road and Fremont Avenue.

Traffic Concerns: Measured traffic speeds on Springer Road are approaching 40 mph. The measured speed is more than 5 mph over the posted speed limit; therefore enforcement by radar is not permitted. Parking is allowed on Springer Road fronting single family homes. Intermittent sidewalks are provided along Springer Road. Where sidewalks are not provided, pedestrians walk alongside bicycles and passenger vehicles within the existing Class II bicycle lanes.



Recommended Tools: The tools selected for this section aim to reduce traffic speeds by as much as 9 mph to conform with the posted speed limit. The surrounding residential character on Springer Road is suitable for several traffic calming features, including vertical deflection. To successfully slow traffic to the desired speed range (30-35 mph) the devices should be spaced close together (600 to 900 feet) and should work together as a system to avoid diversion of traffic to local streets. Considerations should be made to minimize impacts to parking and access to residential driveways.

As such, the following devices were identified as feasible:

- **Median:** narrows the width of the travel lanes and forces movement of traffic away from the center of the road, resulting in a 4 to 5% reduction in speed
- **Raised Crosswalk:** up to 20% reduction in speed
- **Choker:** narrows the width of the travel lanes by constructing islands on each edge of the travel way, resulting in a 4 to 6% reduction in speed
- **Mound:** changes pavement surface to draw drivers' attention

In addition to these traffic calming tools, treated Class II bicycle lanes are proposed to improve the bicycling environment. The traffic calming devices are anticipated to result in an average 5 to 10 mph decrease in speed along Springer Road between Fremont Avenue and Cuesta Drive. Medians and chokers are recommended for a majority of this segment, which visually and physically narrow the roadway to reduce speeds. Existing access would not be changed. The raised crosswalk is proposed at an existing crosswalk location to improve crossing conditions and lower speeds. A mound is recommended to replace the existing curb between the northbound through and northbound right-turn lanes (see photo, left) at the intersection of Springer Road and Berry Avenue, which provides access to Loyola Elementary School. Springer Road includes shared right-of-way with the City of Mountain View. In locations where right-of-way is shared, the costs for new traffic calming measures shall be shared with the City of Mountain View.



Existing Conditions

Legend:

- #### Average Daily Traffic (2007, Source: City)
- # = Number of Accidents 2000 to 2008 (Where Recorded)
- ⓐ Class "A" Study Intersection (Traffic Commission Rank 13 - 15)
- ⓑ Class "B" Study Intersection (Traffic Commission Rank 11 - 12)
- ⓒ Class "C" Study Intersection (Traffic Commission Rank 7 - 10)
- ⓓ Class "D" Study Intersection (Traffic Commission Rank 6 or less)
- Bike Lanes located on Collectors (Draft Bike Plan 2010)
 - Existing Class II
 - Existing Class III
 - ⋯ Proposed Class III
- VMS SPEED LIMIT SIGN VMS = Variable Message Sign (Radar Speed Sign)
- ## / ## MPH 85th% / Posted Speeds

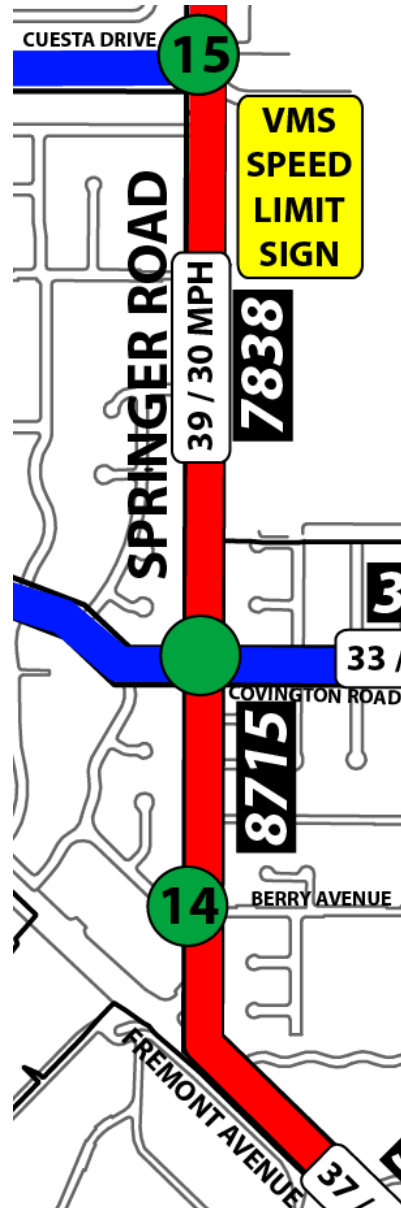

Proposed Traffic Calming

Legend:

- New Standard Roundabout
- New Mini-Roundabout
- ▲ Bulbout (At Intersection)
- Raised Intersection
- Raised Crosswalk / Speed Table
- Surface Treatment / Mound
- Median
- Choker
- ~ Meandering Roadway
- *Note: Treated Class II bicycle lanes to be considered along the following Collectors
 - Fremont Avenue
 - Grant Road
 - Springer Road
 - El Monte Avenue

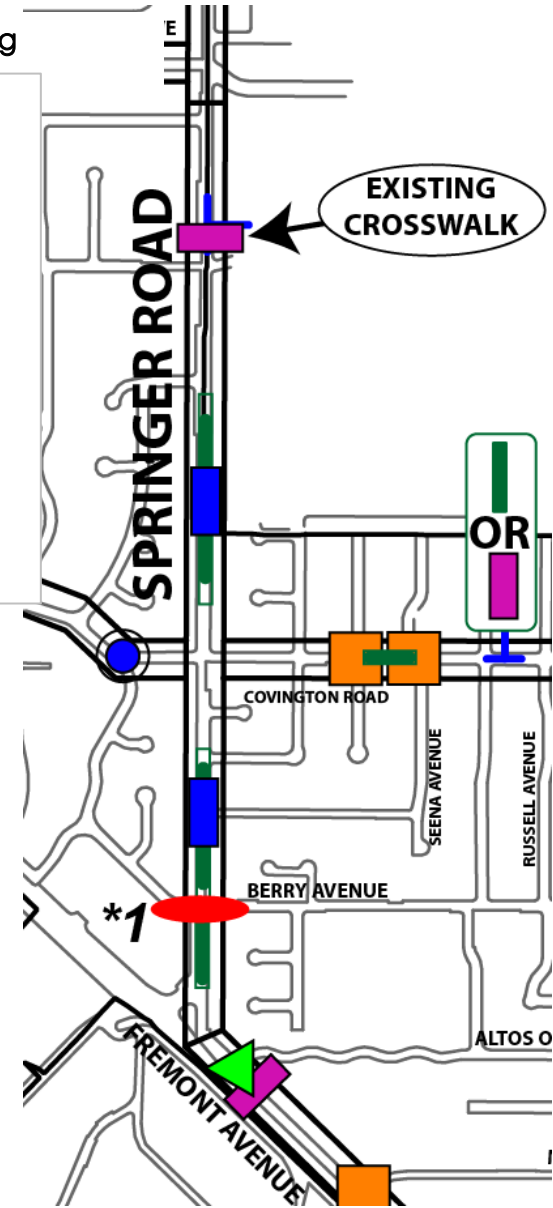



4.20 Springer Road: Cuesta Drive to City Boundary (Hollingsworth Drive)

Surrounding Land Uses: Between Cuesta Drive and the City Boundary (Hollingsworth Drive) Springer Road is a two-lane roadway that is fronted by single-family homes.

Traffic Concerns: Measured traffic speeds along Springer Road are approaching 40 mph. Enforcement by radar is not permitted as the difference in measured to posted speed is more than 5 mph. Intermittent sidewalks are provided along Springer Road. Where sidewalks are not provided, pedestrians walk alongside bicycles and passenger vehicles within the existing Class II bicycle lanes. Line-of-sight at some driveways and intersections is shielded by existing landscaping.



Recommended Tools: The tools selected for this section aim to reduce traffic speeds to conform with the posted speed limit and improve pedestrian and bicycle environments. This roadway segment varies in width; therefore the traffic calming devices were selected to suit the available right-of-way. To successfully slow traffic to the desired speed range (30-35 mph) the devices should be spaced close together (600 to 900 feet) and should work together as a system to maintain consistently lower speeds along the corridor. Mixing the devices or pairing them at key locations will be more effective than the placement of a single device.

As such, the following devices were identified as feasible:

- **Median:** narrows the width of the travel lanes and forces movement of traffic away from the center of the road, resulting in a 4 to 5% reduction in speed
- **Bulbout:** reduce pedestrian crossing distance by as much as 16 to 20 feet. Combining a bulbout with a median significantly narrows the travel way at the intersection and reduces speeds by up to 15%
- **Roundabout:** raised circular islands placed in the middle of an intersection to reduce speeds up to 15% and maintain traffic flow with greater speed reduction through the intersection

Working together, the traffic calming devices are anticipated to result in an average 5 to 10 mph decrease in speed along Springer Road between Cuesta Drive and N. El Monte Avenue. Medians are recommended along the majority of this segment, which visually and physically narrow the roadway to reduce speeds. Existing access would not be changed. A roundabout is recommended at the intersection of Springer Road and Marilyn Drive-Camellia Way, which would reduce speeds and improve traffic flow through the intersection. A roundabout or bulbout is also proposed at the intersection of Springer Road and El Monte Avenue. The design of the roundabout or bulbout will be designed to retain the existing trees at the intersection. Springer Road includes shared right-of-way with the City of Mountain View. In locations where right-of-way is shared, the costs for new traffic calming measures shall be shared with the City of Mountain View.



Existing Conditions

Legend:

- ### Average Daily Traffic (2007, Source: City)
- # = Number of Accidents 2000 to 2008 (Where Recorded)
- Class "A" Study Intersection (Traffic Commission Rank 13 - 15)
- Class "B" Study Intersection (Traffic Commission Rank 11 - 12)
- Class "C" Study Intersection (Traffic Commission Rank 7 - 10)
- Class "D" Study Intersection (Traffic Commission Rank 6 or less)
- Bike Lanes Located on Collectors (Draft Bike Plan 2010)
 - Existing Class II
 - Existing Class III
 - Proposed Class III
- VMS SPEED LIMIT SIGN VMS = Variable Message Sign (Radar Speed Sign)
- ## / ## MPH 85th% / Posted Speeds

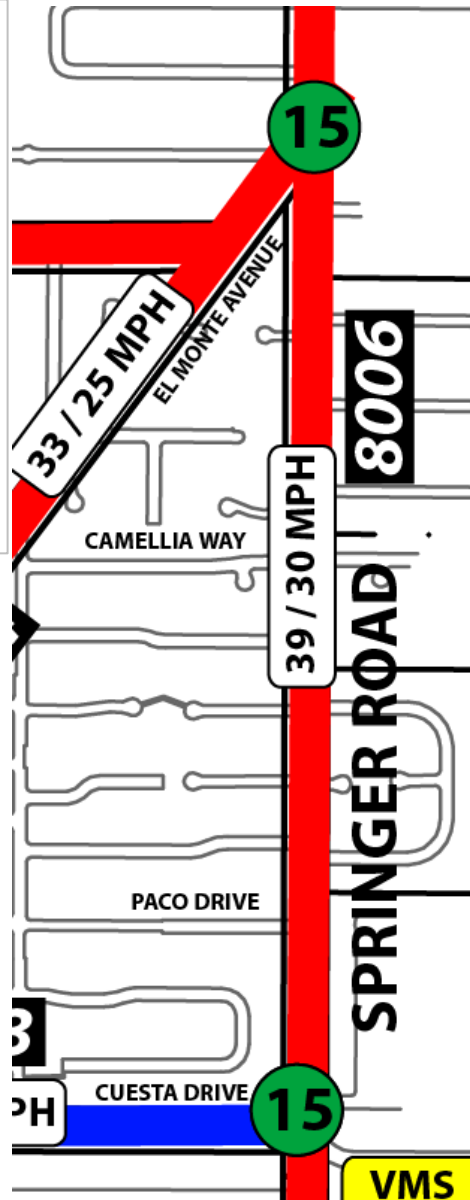

Proposed Traffic Calming

Legend:

- New Standard Roundabout
- New Mini-Roundabout
- ▲ Bulbout (At Intersection)
- Raised Intersection
- Raised Crosswalk / Speed Table
- Surface Treatment / Mound
- Median
- Choker
- ~ Meandering Roadway

**Note: Treated Class II bicycle lanes to be considered along the following Collectors*

- Fremont Avenue
- Grant Road
- Springer Road
- El Monte Avenue

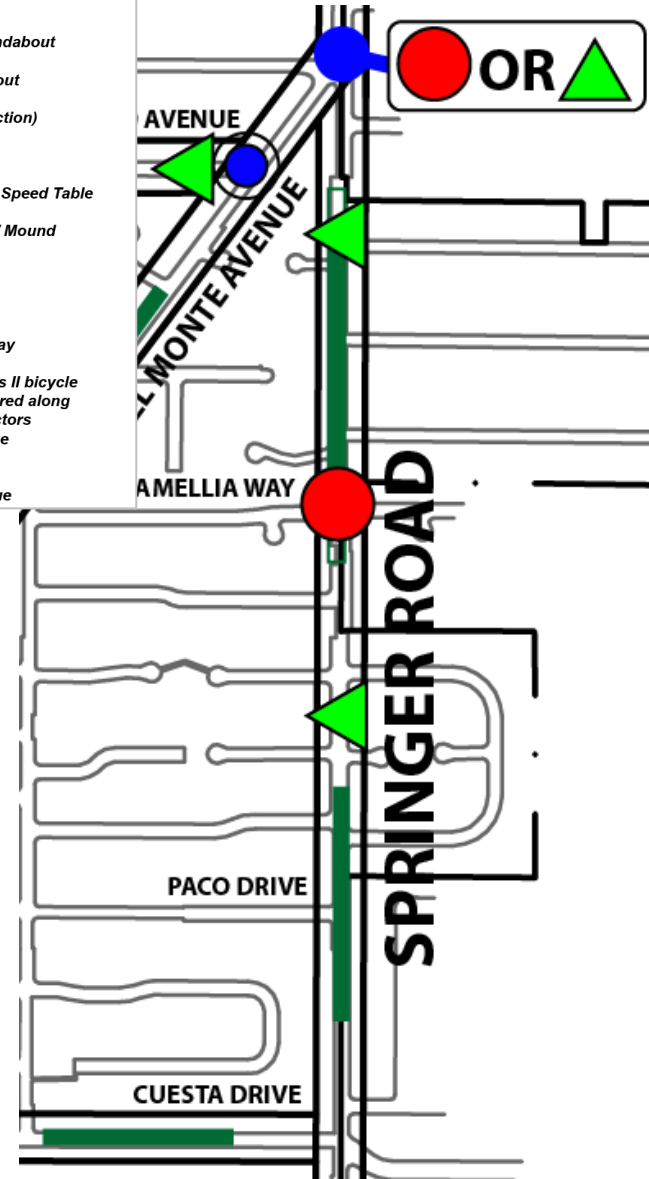



4.21 St. Joseph Avenue: Foothill Expressway to St. Mathew

Surrounding Land Uses: Between Foothill Expressway and St. Mathew, St. Joseph Avenue consists of single-family residential homes and provides direct access to Montclair Elementary School.

Traffic Concerns: St. Joseph Avenue carries over 4,000 vehicles per day. Sidewalks are currently provided, but there are no bicycle facilities. Yellow pedestrian crossings are marked along the street approaching the elementary school. Speeding is prevalent due to the large width of the roadway. A VMS radar speed sign is being considered. In addition, this street is part of the Safe Routes to School Program.



Recommended Tools: The tools selected for this section aim to reduce traffic speeds to conform with the posted speed limit and improve the pedestrian environment, particularly for students walking to and from school. The characteristics of St. Joseph Avenue are suitable for vertical and horizontal deflection traffic calming measures. To successfully slow traffic to the desired speed range (25-30 mph) the devices should be spaced close together (500 to 800 feet) and should work together as a system to avoid diversion of traffic to local streets and to maintain consistently lower speeds along the corridor. Considerations should be made to minimize impacts to parking in residential driveways.

As such, the following devices were identified as feasible:

- **Bulbout:** reduces pedestrian crossing distance by as much as 10 to 15 feet and improve visibility of pedestrians and crosswalks
- **Raised Crosswalk:** up to 20% reduction in speed
- **Raised Intersection:** up to 10% reduction in speed

In addition to these measures, a Class III bike facility is proposed. Working together, the traffic calming devices are anticipated to result in an approximately 10 mph decrease in speed and an improved pedestrian and bicycling environment along St. Joseph Avenue. Bulbouts are proposed at the intersection of St. Joseph Avenue and the Foothill Expressway, which would narrow the crossing distance and slow the speeds, especially for turning vehicles. A raised crosswalk is proposed to replace the existing crosswalk near Granger Avenue. A raised intersection is proposed in the middle of the segment.



Existing Conditions

Legend:

Average Daily Traffic (2007, Source: City)

= Number of Accidents 2000 to 2008 (Where Recorded)

- Class "A" Study Intersection (Traffic Commission Rank 13 - 15)
- Class "B" Study Intersection (Traffic Commission Rank 11 - 12)
- Class "C" Study Intersection (Traffic Commission Rank 7 - 10)
- Class "D" Study Intersection (Traffic Commission Rank 6 or less)

Bike Lanes located on Collectors (Draft Bike Plan 2010)

- Existing Class II
- Existing Class III
- Proposed Class III

VMS = Variable Message Sign (Radar Speed Sign)

/ ## MPH 85th% / Posted Speeds

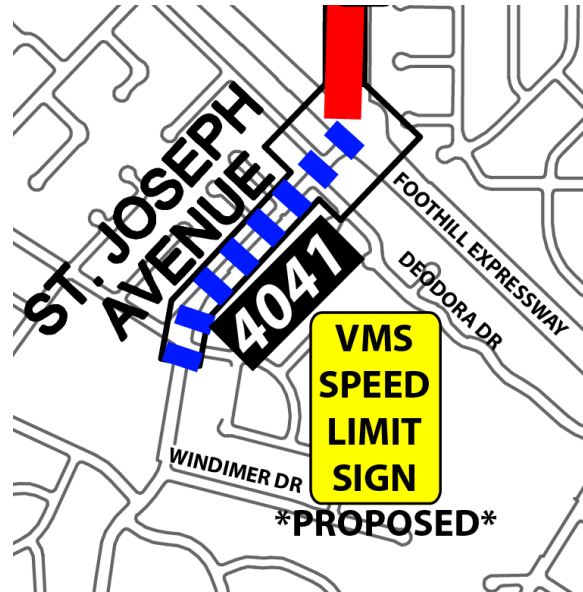

Proposed Traffic Calming

Legend:

- New Standard Roundabout
- New Mini-Roundabout
- ▲ Bulbout (At Intersection)
- Raised Intersection
- Raised Crosswalk / Speed Table
- Surface Treatment / Mound
- Median
- Choker
- ~ Meandering Roadway

*Note: Treated Class II bicycle lanes to be considered along the following Collectors

- Fremont Avenue
- Grant Road
- Springer Road
- El Monte Avenue

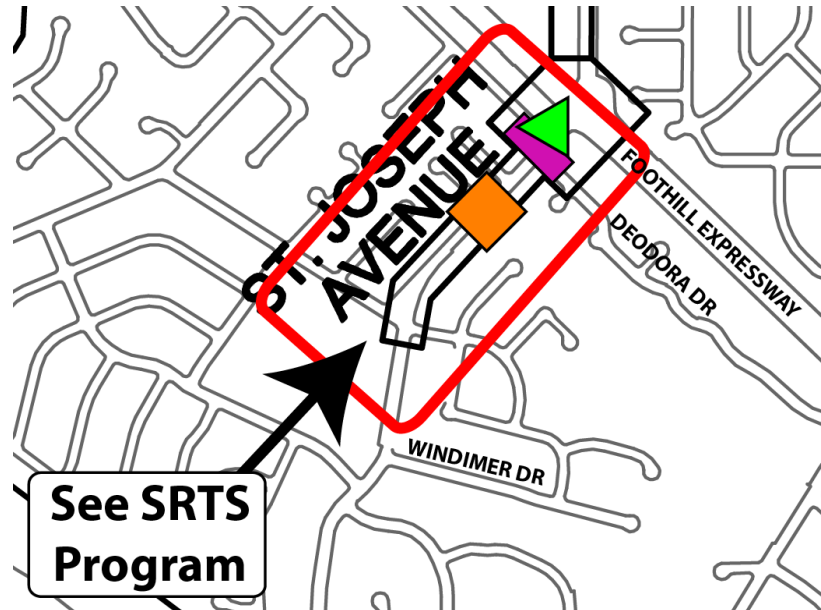



4.22 Traffic Calming Plan Element Costs

The following table presents an opinion of probable costs of typical traffic calming devices indentified for the collector streets included in the plan. Where improvements have been implements, costs have not been included in the sub-totals. Several improvements on Springer Road can be shared with the City f Mountain View. A 50/50 split in costs is calculated as noted in the table.

Table 4.2: Estimated Costs of Traffic Calming Devices

Location		Preferred Traffic Calming Measure (Most Effective)	Alternative Traffic Calming Measure (Less Effective)	Preferred Measure Cost	Alternative Measure Cost	Comments
Collector	Nearest Cross Street					
Almond	San Antonio	Surface Treatment		\$5,000		
Almond	San Antonio	Surface Treatment		\$5,000		
Almond	Valencia	Surface Treatment		\$5,000		
Almond	Valencia	Bulb-Out		\$40,000		
Almond	Valencia	Raised Crosswalk	Median	\$15,000	\$15,000	
Almond	Valencia	Raised Crosswalk	Median	\$15,000	\$15,000	
Almond	N Gordon	Raised Crosswalk	Median	\$15,000	\$15,000	
Almond	Alicia	Raised Intersection		\$150,000		
Almond	N Avalon	Raised Intersection		\$150,000		
Almond	N Clark	Raised Crosswalk	Median	\$15,000	\$15,000	
Almond	N Clark	Raised Crosswalk	Median	\$15,000	\$15,000	Constructed
Almond	Higgins	Bulb-Out		\$40,000		
Almond	El Monte	Bulb-Out		\$40,000		
Almond	El Monte	Mini-Roundabout		\$25,000		
Covington	Fremont	Raised Crosswalk	Median	\$15,000	\$15,000	
Covington	Bellevue	Median		\$15,000		
Covington	Bellevue	Raised Intersection		\$150,000		
Covington	Bellevue	Median		\$15,000		
Covington	Bellevue	Median		\$15,000		
Covington	Campbell	Median		\$15,000		
Covington	Echo	Mini-Roundabout		\$25,000		
Covington	Riverside	Mini-Roundabout		\$25,000		
Covington	Leonello	Raised Intersection		\$150,000		
Covington	Leonello	Median		\$15,000		



Location		Preferred Traffic Calming Measure (Most Effective)	Alternative Traffic Calming Measure (Less Effective)	Preferred Measure Cost	Alternative Measure Cost	Comments
Covington	Seena	Raised Intersection		\$150,000		
Covington	Golden	Raised Crosswalk	<i>Median</i>	\$15,000	<i>\$15,000</i>	
Covington	Eastwood	Median		\$15,000		
Covington	Eastwood	Median		\$15,000		
Covington	Hayman	Median		\$15,000		
Covington	Hayman	Raised Crosswalk		\$15,000		
Covington	Thatcher	Raised Crosswalk		\$15,000		
Cuesta	Tyndall	Mini-Roundabout		\$25,000		
Cuesta	Gabilan	Mini-Roundabout		\$25,000		
Cuesta	Arboleda	Raised Intersection		\$150,000		
Cuesta	Arboleda	Median		\$15,000		
Cuesta	S Clark	Median		\$15,000		
W. Edith	2nd	Median		\$15,000		
W. Edith	2nd	Bulb-Out		\$40,000		
W. Edith	3rd	Bulb-Out		\$40,000		
W. Edith	View	Raised Crosswalk		\$15,000		
W. Edith	4th	Bulb-Out		\$40,000		
W. Edith	Plaza	Surface Treatment		\$5,000		
El Monte	Springer	Standard Roundabout	<i>Bulb-Out</i>	\$300,000	<i>\$40,000</i>	
El Monte	El Monte Ct	Median		\$15,000		
El Monte	Higgins	Bulb-Out		\$40,000		
El Monte	Santa Barbara	Bulb-Out		\$40,000		
El Monte	Hawthorne	Mini-Roundabout		\$25,000		
El Monte	Paco	Mini-Roundabout		\$25,000		
El Monte	Edna	Median		\$15,000		
El Monte	Edna	Raised Intersection		\$150,000		
El Monte	Shirlynn	Meandering Roadway		\$40,000		
El Monte	Shirlynn	Median		\$15,000		
Fremont	Altos Oaks	Bulb-Out		\$40,000		
Fremont	Altos Oaks	Raised Crosswalk		\$15,000		
Fremont	Manor	Raised Intersection		\$150,000		
Fremont	Loraine	Raised Crosswalk		\$15,000		
Fremont	Loraine	Bulb-Out		\$40,000		



Location		Preferred Traffic Calming Measure (Most Effective)	Alternative Traffic Calming Measure (Less Effective)	Preferred Measure Cost	Alternative Measure Cost	Comments
Fremont	Lorraine	Bulb-Out		\$40,000		
Fremont	Kensington	Raised Crosswalk		\$15,000		
Fremont	Lisa	Bulb-Out		\$40,000		
Fremont	Grant	Median		\$15,000		
Fremont	Julie / Austin	Median		\$95,000		
Fremont	Kathy	Median	<i>Meandering Roadway</i>	\$15,000	\$40,000	
Fremont	Randolph	Standard Roundabout		\$300,000		
Fremont	New Castle	Standard Roundabout		\$300,000		
Fremont	Truman	Standard Roundabout		\$300,000		
Fremont	Fallen Leaf	Standard Roundabout		\$300,000		
Fremont	Belleville	Bulb-Out		\$40,000		
Fremont	Fallen Leaf	Median	<i>Meandering Roadway</i>	\$15,000	\$40,000	
Grant	Eureka	Standard Roundabout		\$300,000		
Grant	Oak	Raised Intersection		\$150,000		
Grant	Garthwick	Bulb-Out		\$40,000		
Grant	Richardson	Median		\$15,000		
Grant	Green Oak	Standard Roundabout		\$300,000		
Grant	Morton	Raised Crosswalk		\$15,000		<i>Constructed</i>
Los Altos	Santa Rita Ct	Bulb-Out		\$40,000		
Los Altos	Lunada	Median		\$15,000		
Los Altos	Lunada	Raised Crosswalk	<i>Median</i>	\$15,000	\$15,000	
Los Altos	Santa Rita Ave	Median		\$15,000		
Los Altos	W Portola	Bulb-Out		\$40,000		
Los Altos	W Portola	Surface Treatment		\$5,000		
Los Altos	Vernal	Raised Crosswalk	<i>Median</i>	\$15,000	\$15,000	
Los Altos	Alba	Bulb-Out		\$40,000		
Los Altos	Becker	Median		\$15,000		
Los Altos	Hacienda	Raised Intersection		\$150,000		
Los Altos	Yerba Buena	Median		\$15,000		
Los Altos	Yerba Buena	Bulb-Out		\$40,000		
Los Altos	Surrey	Bulb-Out		\$40,000		
Los Altos	W. Edith	Median		\$15,000		



Location		Preferred Traffic Calming Measure (Most Effective)	Alternative Traffic Calming Measure (Less Effective)	Preferred Measure Cost	Alternative Measure Cost	Comments
Main	1st	Surface Treatment		\$5,000		
Main	State	Surface Treatment		\$5,000		
Main	State	Bulb-Out		\$40,000		
Main	San Antonio	Surface Treatment		\$5,000		
Miramonte	Eastwood	Mini-Roundabout		\$25,000		
Miramonte	Berry	Raised Intersection		\$150,000		
Miramonte	Portland	Median		\$15,000		
Miramonte	Altos Oaks	Median		\$15,000		
Miramonte	Clinton	Bulb-Out		\$40,000		
Miramonte	Loraine	Raised Intersection		\$150,000		
Springer	Vista Grande	Bulb-Out		\$40,000		
Springer	Raymundo	Median		\$60,000		
Springer	Camellia	Standard Roundabout		\$300,000		Cost Shared with Mountain View 50/50
Springer	San Martin	Bulb-Out		\$40,000		
Springer	Paco	Median		\$60,000		Cost Shared with Mountain View 50/50
Springer	Rosita	Raised Crosswalk	Median	\$15,000	\$15,000	Constructed
Springer	Riverside	Choker		\$15,000		Cost Shared with Mountain View 50/50
Springer	Edge	Choker		\$15,000		
Springer	Berry	Median		\$60,000		
Springer	Berry	Surface Treatment		\$5,000		
St. Joseph	Granger	Bulb-Out		\$40,000		
St. Joseph	Granger	Raised Crosswalk		\$15,000		
St. Joseph	Robles Ranch	Raised Intersection		\$150,000		

	Sub-total		\$6,312,500	\$6,007,500
Contingencies	20%		\$1,262,500	\$1,201,500
Engineering & Design	15%		\$946,875	\$901,125
Administration	15%		\$946,875	\$901,125
	Grand Total		\$9,468,750	\$9,011,250



4.23 Process of Ranking the Collector Streets

Based on the technical data and cost of the Plan improvements, the collectors were rated and ranked by the following criteria:

- Number of accidents on the corridor.
- Preferred alternative costs per vehicle based on the recorded traffic volumes.
- Priority intersections on the corridor based upon the City of Los Altos ranking criteria (see Appendix B).
- Speed reduction based on the preferred traffic calming measures.
- Average daily volumes.

Each category is ranked on a weighted average scale with a given grade from 1 to 4, least to most critical. All categories are equally weighted in the total ranking. Based on the ranking, the following corridor priorities are established and listed from critical (Fremont Avenue) to least critical (Main Street).

Table 4.3: Corridor Ranking

Corridor	Accident Category		Cost Category				Priority Intersection Category		Speed Reduction Category		Volume Category		Total Ranking (subtotal of all categories)
	# of Accidents	Ranking	Cost	Highest Traffic Volume	Cost Per Vehicle	Ranking	Total Points	Ranking	Avg Speed Reduction	Ranking	Highest Volume	Ranking	
Fremont Avenue	84	4	\$ 2,460,000	19,258	\$ 128	2	3	2	8	4	19,258	4	16
Springer Road	44	2	\$ 611,250	8,715	\$ 70	3	9	4	8	4	8,715	2	15
El Monte Avenue	80	4	\$ 997,500	7,294	\$ 137	2	11	4	7	3	7,294	2	15
W. Edith Avenue	89	4	\$ 232,500	6,189	\$ 38	4	4	2	5	3	6,189	2	15
Grant Road	40	2	\$ 1,207,500	20,563	\$ 59	3	2	1	9	4	20,563	4	14
Cuesta Drive	42	2	\$ 345,000	7,333	\$ 47	4	5	2	6	3	7,333	2	13
Miramonte Avenue	26	2	\$ 592,500	7,705	\$ 77	3	8	4	4	2	7,705	2	13
Almond Avenue	28	2	\$ 780,000	5,439	\$ 143	2	6	3	3	2	5,439	2	11
Covington Road	64	3	\$ 1,020,000	5,011	\$ 204	1	8	4	3	2	5,011	1	11
Los Altos Avenue	11	1	\$ 690,000	4,005	\$ 172	1	11	4	3	2	4,005	1	9
St. Joseph Avenue	0	1	\$ 307,500	4,041	\$ 76	1	4	4	0	2	4,041	1	9
Main Street	0	1	\$ 82,500	4,836	\$ 17	4	0	1	0	1	4,836	1	8

Notes:

For each category, each corridor is ranked on a weighted average scale with a given grade from 1 to 4, least to most critical. All categories are equally weighted.



5.0 Traffic Diversion

Implementation of the Collector Traffic Calming Plan could have the potential for traffic to divert to other roadways and into adjacent neighborhoods as drivers will look for roadways without traffic calming measures.

5.1 Candidate Diversion Routes

Although the City's roadway network is laid out in a typical grid format, there are a limited number of roadways that provide a through and straight connection between arterials and collectors. Most neighborhood streets are curvy-linear and narrow, and are not conducive to high-speed travel.

The following roads were tentatively identified as potential locations that may experience an increase in traffic with implementation of the Traffic Calming Plan:

To Bypass Fremont Avenue, Grant Road, or Covington Road

- Truman Avenue
- Oak Avenue
- Bryant Avenue
- Portland Avenue
- Fallen Leaf Lane
- Oakhurst Avenue
- Altos Oaks Drive
- Manor Way
- Dolores Avenue
- Grant Road (north of Covington Road) (City of Mountain View)
- Cuesta Drive (east of Springer Road) (City of Mountain View)

To Bypass Cuesta Drive, El Monte Avenue, or Almond Avenue

- Arboleda Drive
- Paco Drive
- Higgins Avenue
- Jardin Drive



To Bypass Los Altos Avenue

- Pine Lane
- Portola Avenue
- San Antonio Road

To Bypass West Edith Avenue

- Mt. Hamilton Avenue

The Plan does not recommend using speed hump/bumps on collector streets since they may create greater traffic diversion.

5.2 Monitoring and Preventing Re-Routing

A component of a successful plan is the evaluation and monitoring of prior traffic conditions versus the results of post traffic calming device installation. Follow-up studies should be conducted to evaluate the measures of a project's success and to determine if the traffic problem has shifted to other neighborhood streets.

When applicable, methods by which follow-up studies should be conducted include:

- Speed Before and After Surveys
- Traffic Volume Before and After Study
- Diversion Study

The results of the follow-up studies will serve as a baseline to monitor the amount of traffic that has diverted to neighboring streets. If before and after traffic counts reveal adjacent streets are significantly impacted, additional traffic calming measures should be implemented on streets with cut-through following the planning and outreach procedures outlined in the 2005 Neighborhood Traffic Management Program.



6.0 Traffic Calming Concept Design: Fremont Avenue Corridor

6.1 Overview

Due to emergency response concerns and high traffic volumes, a refined concept plan has been developed for the Fremont Avenue corridor. The concept design incorporates a series of four roundabouts along Fremont Avenue. Roundabouts are the preferred traffic calming measure for Fremont due to the high traffic volumes and need to reduce speeds along the corridor. The Fremont Avenue corridor concept is included in **Appendix A**.

6.2 Traffic Operations

The Traffic Calming Plan also allows for implementation of roundabouts as a traffic calming measure. Roundabouts provide superior benefits to side-street stop control and signalized intersections in terms of reducing delay, noise sustainability and greenhouse gas emissions. Level of service (LOS) calculations were conducted for the existing AM and PM peak-hour operations for the following intersections in the Fremont Avenue corridor:

- Fremont Avenue/Austin Avenue – Julie Lane
- Fremont Avenue/Newcastle Drive
- Fremont Avenue/Truman Avenue
- Fremont Avenue/Fallen Leaf Lane

Level of service calculations are indicated in the following table and included in **Appendix C**.



Table 6.1: Fremont Avenue Intersection LOS:
Two-way stop control versus roundabout control

Intersection				Two-way Stop Control		Roundabout	
N/S Street	E/W Street			Delay ** (Seconds)	LOS*	Delay (Seconds)	LOS*
Randolph Parkway	Fremont Avenue	AM				6.6	A
			Worst Approach	67.7 (NB)	F	16.9 (NB)	C
		PM				6.5	A
			Worst Approach	233.4 (NB)	F	21.9 (SB)	C
Newcastle Drive	Fremont Avenue	AM	Average			6.3	A
			Worst Approach	239.5 (NB)	F	17.6 (NB)	B
		PM	Average			5.9	A
			Worst Approach	276.4 (NB)	F	21.0 (NB)	C
Truman Avenue	Fremont Avenue	AM	Average			11.4	B
			Worst Approach	1953.3 (SB)	F	45.4 (SB)	D
		PM	Average			7.2	A
			Worst Approach	626.9 (SB)	F	16.8 (SB)	B
Fallen Leaf Lane	Fremont Avenue	AM	Average			7.7	A
			Worst Approach	828.4 (NB)	F	32.7 (SB)	C
		PM	Average			8.3	A
			Worst Approach	423.8 (NB)	F	24.7 (NB)	C

*LOS methodology for delay & LOS calculation is 2010 HCM (Highway Capacity Manual)

**For Two-way stop controlled intersections the LOS (Average Delay) for vehicles is not applicable since the average intersection delay is not a good LOS measure due to zero delays associated with major road movements.

*** NB = Northbound, SB = Southbound, EB = Eastbound, WB= Westbound Approaches

The results of the LOS calculations from the Signalized and Unsignalized Intersection Design and Research Aid (SIDRA) software program indicated that the side streets at each study intersection above are operating at LOS F under stop control. This indicates vehicles have difficult and lengthy delays when turning onto Fremont Avenue. This collaborates with the extensive traffic queuing along Fremont Avenue that was noted by the public as well. The proposed roundabout would improve operations (to LOS D for worst movement) at these intersections as vehicles are not required to come to a stop but instead would yield to circulating vehicles in the roundabout.



In addition, the roundabout would further reduce greenhouse gas emissions and the amount of gasoline consumed as vehicles would not be required to come to a stop. A review of the emission outputs from the SIDRA calculation sheets indicate that a reduction of between 7 and 20 percent in greenhouse gases (carbon dioxide, hydrocarbons, carbon monoxide, and oxides of nitrogen) would be achieved during the peak hours. Greenhouse gas emissions are shown in the intersection level of service calculations in **Appendix C**.

6.3 Stevens Creek Trail Study

The proposed traffic calming measures along Fremont Avenue have been designed in accordance with the design requirements of the Stevens Creek Trail Study. The study plans for the implementation of a Class I multi-use trail along Fremont Avenue between the City limits in the east to Grant Avenue in the west. The proposed concept design will accommodate a 10 foot wide planter strip and 16 foot wide multi-use trail along the north side of Fremont Avenue within the existing right-of-way. Where roundabouts are proposed, the Stevens Creek Trail will cross at the crosswalks as indicated at each intersection.

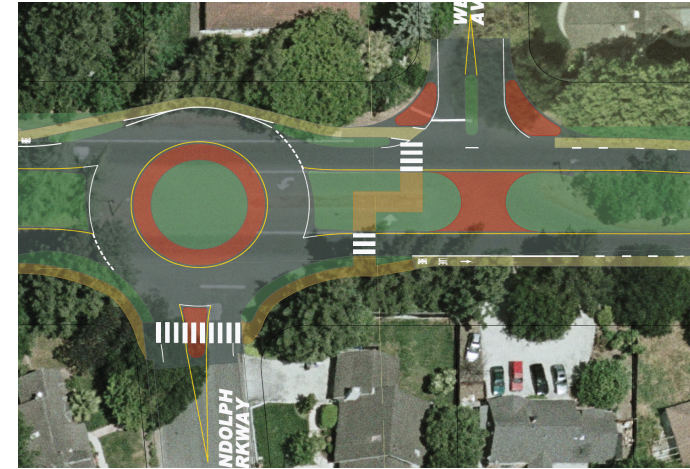

6.4 Cost Estimates and Phasing

An opinion of probable construction costs was developed for the proposed Fremont Avenue concept plan as shown in the following table. This estimate includes contingencies for mobilization, project management and design, construction management and engineering, and an overall contingency. This rough estimate will be refined further in the next phase of design.

The concept can be implemented in phases if the entire corridor cannot be completely funded. The specifics on which portions can be implemented initially will be determined in the next phase of design.



Table 6.2 Fremont Avenue Opinion of Probable Costs
Between City Boundary (Stevens Creek) to Springer

ITEM	DESCRIPTION	UNIT	QUANTITY	UNIT COST	COST
RBF CONSULTING CITY OF LOS ALTOS Los Altos Traffic Control Plan Fremont Street Corridor Geometric-Preliminary 20%					
					6/8/2011
					Prepared By: AT
GENERAL					
1	Mobilization	LS	1	\$7,500.00	\$7,500.00
2	Erosion Control	LS	1	\$2,500.00	\$2,500.00
3	Traffic Control, Barricades and Other Fees	LS	1	\$10,000.00	\$10,000.00
Subtotal					\$20,000.00
STREET IMPROVEMENTS					
4	Roadway Excavation	CY	1	\$7,500.00	\$7,500.00
5	Remove Miscellaneous Concrete	LS	1	\$5,000.00	\$5,000.00
6	Remove Existing Asphalt Concrete Pavement	SF	95,000	\$0.50	\$47,500.00
7	Asphalt Concrete, Type A	TON	1,230	\$80.00	\$98,400.00
8	Aggregate Base, Class 2	CY	2,150	\$45.00	\$96,750.00
9	Miscellaneous PCC Curbs	LF	27,000	\$15.00	\$405,000.00
10	4" PCC Sidewalk	SF	9,000	\$7.00	\$63,000.00
11	Colored AC	SF	97,000	\$0.25	\$24,250.00
12	Concrete Apron	SF	7,710	\$20.00	\$154,200.00
Subtotal					\$901,600.00
MISCELLANEOUS IMPROVEMENTS					
13	Storm Drain Improvements	LS	1	\$150,000.00	\$150,000.00
14	Landscape and Irrigation Improvements	LS	1	\$500,000.00	\$500,000.00
15	Signing and Striping	LS	1	\$30,000.00	\$30,000.00
Subtotal					\$680,000.00
TOTAL					\$1,601,600.00
				Contingency	50% \$800,800.00
TOTAL					\$2,402,400.00



7.0 Impacts to Emergency Vehicles (FIRE)

Traffic calming measures used to control vehicular speeds (speed lumps or humps and raised crosswalks/intersections) and control volumes (full street closure, median barricade, or diagonal diverter) will impact emergency response times. However this study shows that the proposed plan meets the City Council accepted response time of 90% of responses being of 7 minutes or less (see Table 7.1).

7.1 Fire Station Locations

The Santa Clara County Fire Department serves the City of Los Altos. The following map (Figure 3) shows the location of the two County fire stations in Los Altos.

The fire station names and addresses are listed below:

#15 Los Altos
Los Altos Fire Station
10 Almond Ave
Los Altos, CA 94022

#16 Loyola
769 Fremont Ave
Los Altos, CA 94022

Santa Clara County Fire Stations #15 and #16 are located on two of the twelve proposed traffic calming corridors.



Figure 3: Map of Fire Stations in Los Altos

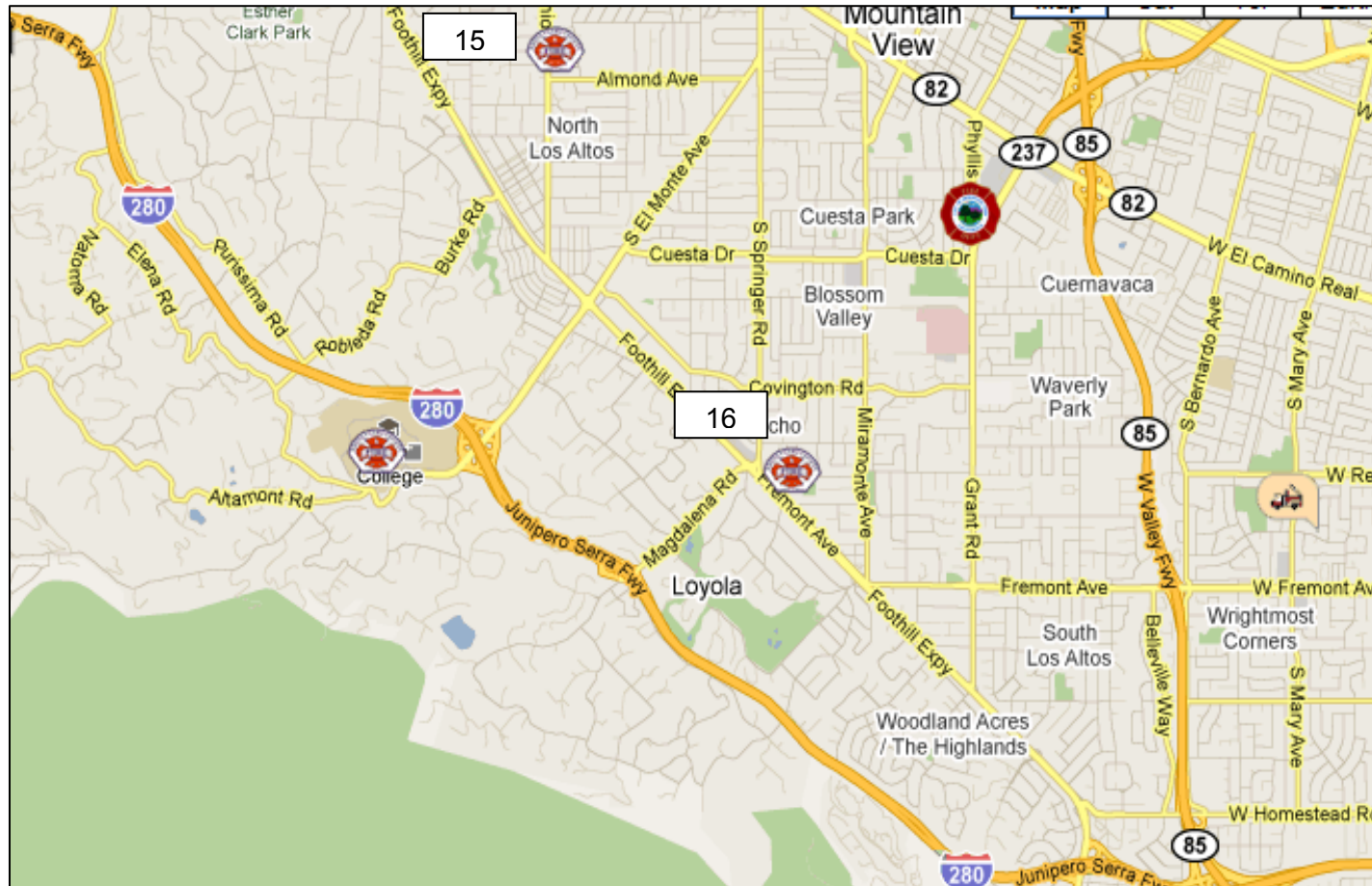

Source: Santa Clara County Fire Department website (<http://www.sccfd.org/stations.html>); Google Maps



7.2 Delay to Fire Vehicles by Type of Device

A recent article, *New Traffic Calming Devices of Choice*, in the Institute of Transportation Engineers Journal (Gulden and Ewing, December 2009) indicated a 10 to 15 second delay to fire trucks with speed humps. Speed humps are not included in the Plan but the proposed raised crosswalks are similar in design (raised crosswalks have a flat surface at the top of the hump to facilitate pedestrian crossings).

The estimated delay for fire trucks (in seconds) per type of traffic calming device is listed below:

- Raised crosswalks – 10 seconds*
- Raised intersections – 1 to 3 seconds**
- Roundabouts – 3 to 4 seconds***
- Bulbouts, medians, chokers, meandering roadways – no delay

*Delay for raised crosswalks assumed to be similar to speed humps.

** Delay for raised intersections based upon comparison of speed reduction between speed humps and raised intersections (Engineering Countermeasures for Reducing Speeds: A Desktop Reference of Potential Effectiveness (Federal Highway Administration, May 2009)). Ratio is then applied to 10 second delay associated for speed humps.

*** A reduction of 30% in the 85th percentile speed can be anticipated for an urban roundabout (see Engineering Countermeasures for Reducing Speeds: A Desktop Reference of Potential Effectiveness). The estimated delay due to roundabouts was calculated by comparing the increase in travel time for a speed of 40 mph versus 28 mph (30% reduction).

Other strategies to minimize delay to fire vehicles can be implemented during the design review phase of the traffic calming measures. For example, the inner median located in roundabouts can be designed to be mountable by fire trucks which will allow these vehicles to travel faster. Also, the fire vehicles can be allowed to travel in the opposing lane when making a left turn at roundabouts instead of navigating the entire circumference. Other design features can be implemented such as mountable bulbouts and ensuring adequate fire truck turning radii are accommodated. Other traffic calming measures, such as speed lumps which are similar to traditional speed humps but with cut-outs to allow fire trucks to travel over without slowing down, can also be considered as an alternative traffic calming measure.



7.3 Impacts to Fire Vehicles from Proposed Traffic Calming Plan

One of the goals of the Santa Clara County Fire Department is to arrive at the scene of emergencies within seven minutes of receipt of an alarm, at least 90 percent of the time for the City of Los Altos. A preliminary analysis was conducted to determine if the fire trucks from the existing stations (on Almond Avenue and on Fremont Avenue) can maintain satisfactory response times with the proposed traffic calming devices. Santa Clara County Fire Department provided response times for the three year period from Year 2007 through 2009. The following table (Table 7.1) presents the 90th percentile response time on each of the 12 proposed traffic calming corridors.

The estimated delay from the proposed traffic calming devices in each corridor was added to the existing 90th percentile response times. The results indicate that the total 90th percentile response time with the added delay from the traffic calming measures is still less than the 7 minute goal for all corridors except for Fremont Avenue. The 90th percentile response time for the Fremont Avenue corridor (when serviced by the Los Altos Station) already exceeds 7 minutes under existing conditions, however, the Los Altos Station only responds to 3 percent of all calls (10 out of 321 calls) on Fremont Avenue. The majority of Fremont Avenue calls are serviced by the Loyola Station which is located on Fremont Avenue. Should Fremont Avenue calls require assistance from the Los Altos Station, no additional delay due to the traffic calming measures are anticipated assuming the fire trucks travel on San Antonio Road to Foothill Expressway to Fremont Avenue.



Table 7.1: Fire Response Times

ID	Corridor	Station	Existing 90th Percentile Response Time (min:sec)	Added Delay from Traffic Calming (min:sec) ¹	Total 90th Percentile Response Time with Traffic Calming (min:sec)	Exceeds 7 Minute Goal?
1	Los Altos Avenue	Los Altos	5:05	0:20	5:25	No
2	West Edith Avenue	Los Altos	3:45	0:10	3:55	No
3	Main Street	Los Altos	3:21	0:00	3:21	No
4	Almond Avenue	Los Altos	3:06	1:04	4:10	No
5	El Monte Avenue	Los Altos	4:09	1:23	5:31	No
6	Cuesta Drive	Los Altos	4:37	0:11	4:48	No
		Loyola	4:31	0:23	4:54	No
7	Springer Road	Los Altos	4:04	1:04	5:08	No
		Loyola	3:13	0:24	3:37	No
8	Covington Road	Los Altos	5:19	0:14	5:32	No
		Loyola	4:07	0:46	4:53	No
9	Miramonte Avenue	Loyola	3:39	0:26	4:05	No
10	Fremont Avenue	Los Altos	7:14*	0:00	7:14	Yes
		Loyola	4:57**	0:35	5:32	No
11	Grant Road	Loyola	4:45	0:37	5:22	No
12	St. Joseph Avenue	Loyola	4:40	0:50	5:30	No

Notes: ¹ Estimated delay per device: raised crosswalk (10 sec), raised intersection (1 sec), roundabout (4 sec), and bulbouts, medians, chokers, meandering roadways (no delay). Delay for raised crosswalks is assumed to be similar to speed humps research (*New Traffic Calming Device of Choice*, Institute of Transportation Engineers Journal, Guiden and Ewing, Dec 2009). Delay for raised intersection based upon comparison of speed reduction between speed humps and raised intersections (Engineering Countermeasures for Reducing Speeds: A Desktop Reference of Potential Effectiveness (Federal Highway Administration, May 2009)). Ratio is then applied to 10 second delay associated for speed humps. A reduction of 30% in the 85th percentile speed can be anticipated for an urban roundabout (see Engineering Countermeasures for Reducing Speeds: A Desktop Reference of Potential Effectiveness). The estimated delay due to roundabout was calculated by comparing the increase in travel time for a speed of 40 mph versus 28 mph (30% reduction).
 * Only 3% of all Fremont Avenue calls (10 out of 321 calls) are served by the Los Altos station.
 ** Reflects 90th percentile response time to eastern Fremont Avenue.



Appendix A

Fremont Avenue Concept Design

INTRODUCTION



The Los Altos Traffic Calming Plan for Fremont Avenue aims to create a safe thoroughfare while preserving and enhancing the existing charming rural ambience of the area.

Lush infill trees and vegetation will reinforce the existing oak woodland character, with punctuations of accent trees and color plantings. The plant palette will require low water usage and maintenance.



Granite monuments along Fremont Avenue will further establish a sense of community and historic character along this vital thoroughfare.

The document will also offer an array of materials, finishes and colors that will combine to create a memorable identity.



This Page Intentionally Left Blank



LEGEND

- Light Blue: Signalized Intersection
- Dark Blue: Roundabout
- Red: Signalized Intersection
- Green: Roundabout
- Yellow: Signalized Intersection
- Orange: Roundabout
- Light Green: Signalized Intersection
- Dark Green: Roundabout

NOTE

1. ALL WORK SHALL BE DONE IN ACCORDANCE WITH THE LATEST EDITIONS OF THE CALIFORNIA STANDARD SPECIFICATIONS FOR HIGHWAY CONSTRUCTION AND THE CALIFORNIA MUTUALITY STANDARDS FOR TRAFFIC CONTROL.

This Page Intentionally Left Blank

MASTER PLAN A



EXISTING AERIAL



LOS ALTOS COLLECTOR TRAFFIC CALMING PLAN - FREMONT AVENUE



EXISTING AERIAL



LOS ALTOS COLLECTOR TRAFFIC CALMING PLAN - FREMONT AVENUE

MASTER PLAN C

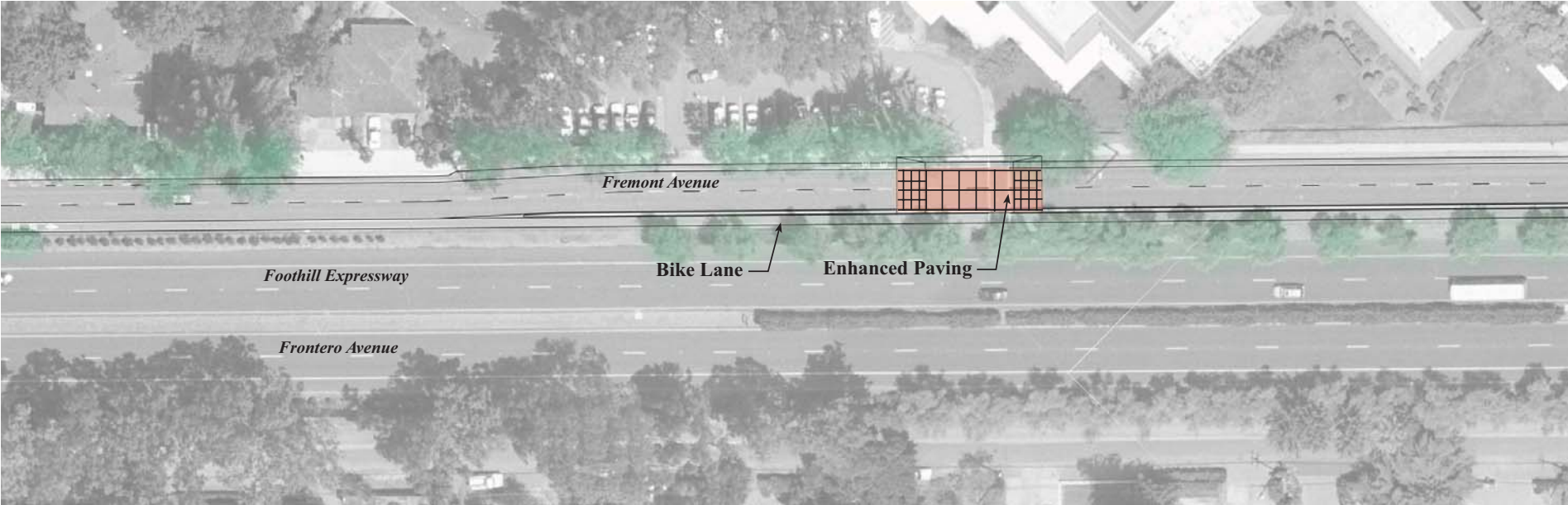

EXISTING AERIAL



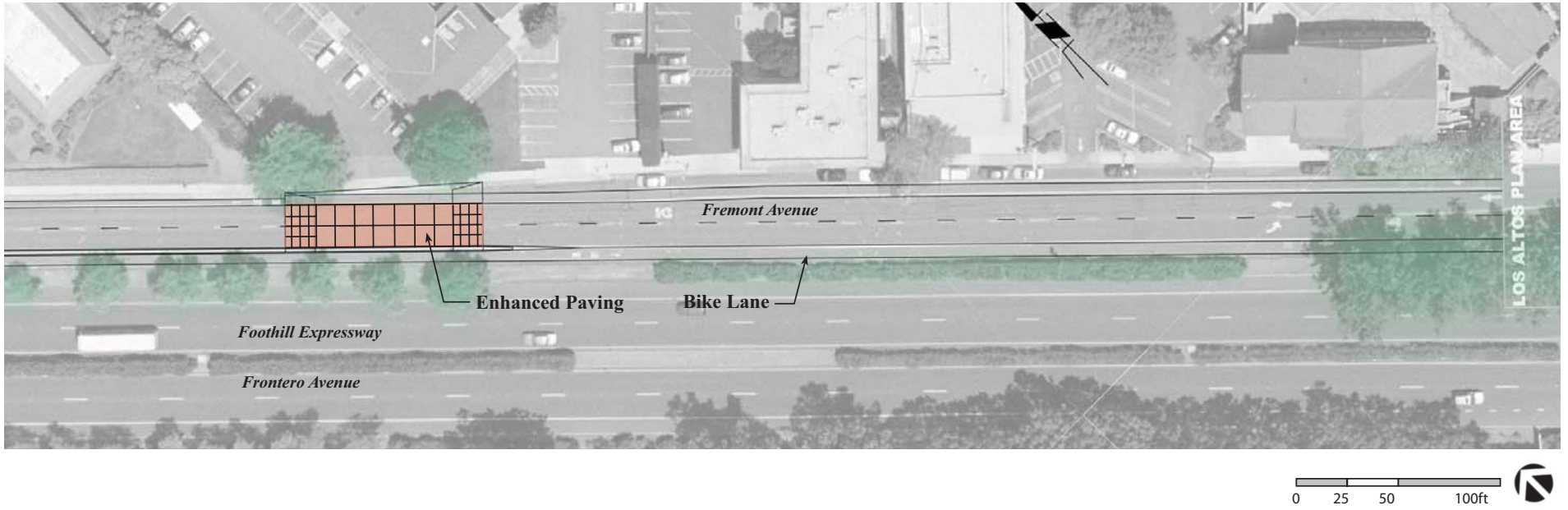

EXISTING AERIAL



LOS ALTOS COLLECTOR TRAFFIC CALMING PLAN - FREMONT AVENUE

MASTER PLAN E

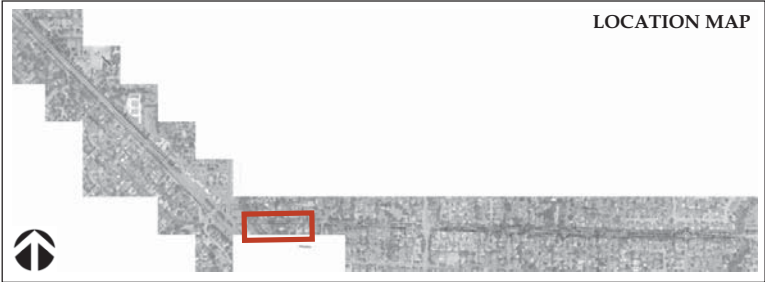

EXISTING AERIAL





EXISTING AERIAL

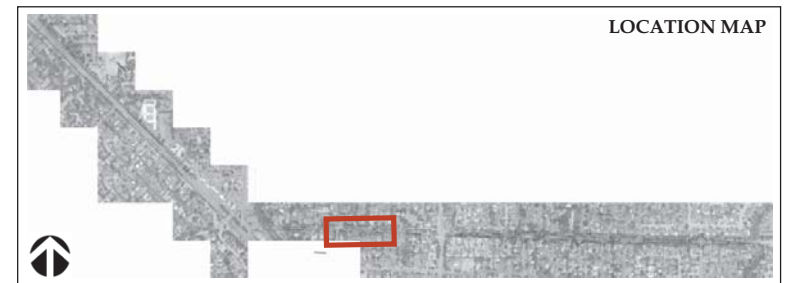

LOS ALTOS COLLECTOR TRAFFIC CALMING PLAN - FREMONT AVENUE

MASTER PLAN G

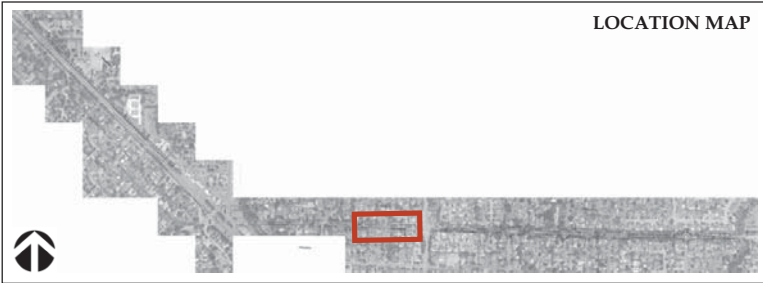

LOS ALTOS COLLECTOR TRAFFIC CALMING PLAN - FREMONT AVENUE



EXISTING AERIAL



LOS ALTOS COLLECTOR TRAFFIC CALMING PLAN - FREMONT AVENUE

MASTER PLAN I

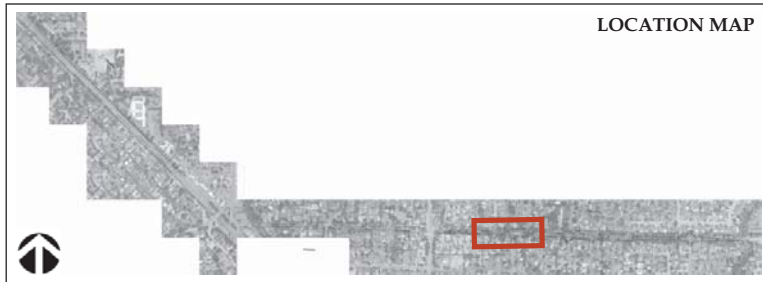

LOS ALTOS COLLECTOR TRAFFIC CALMING PLAN - FREMONT AVENUE



EXISTING AERIAL

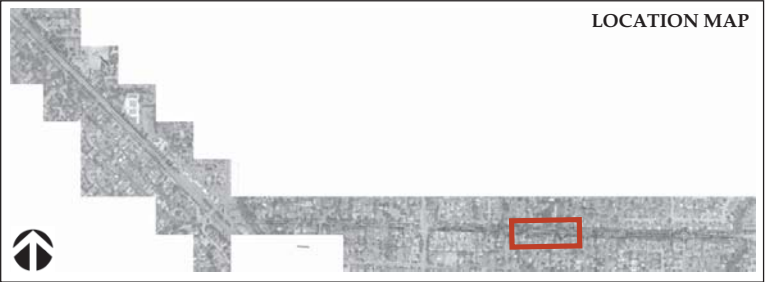

LOS ALTOS COLLECTOR TRAFFIC CALMING PLAN - FREMONT AVENUE

MASTER PLAN K

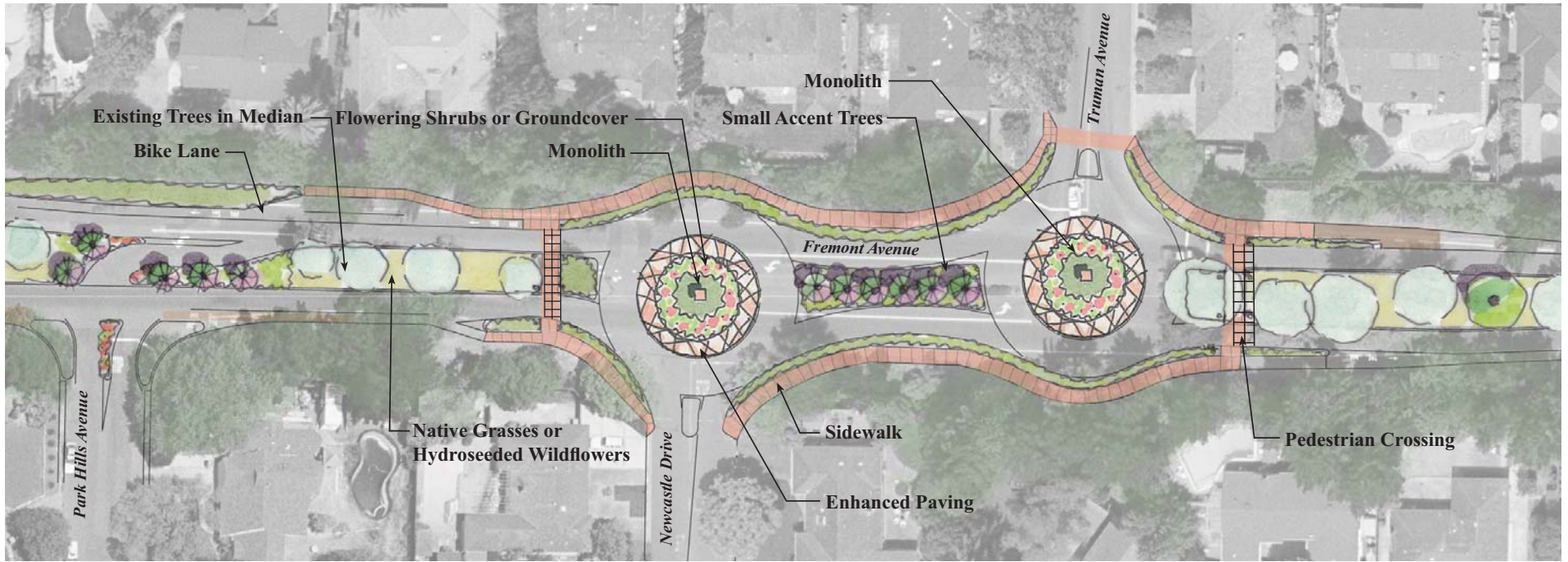

EXISTING AERIAL

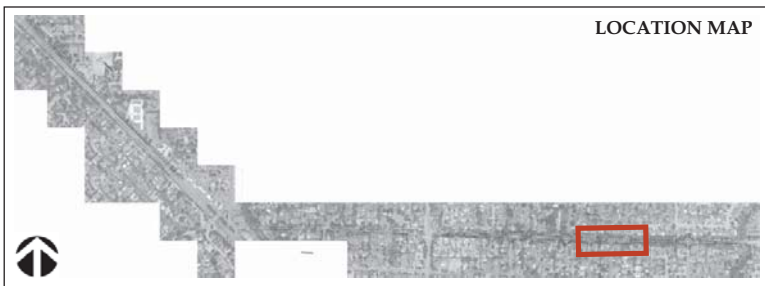

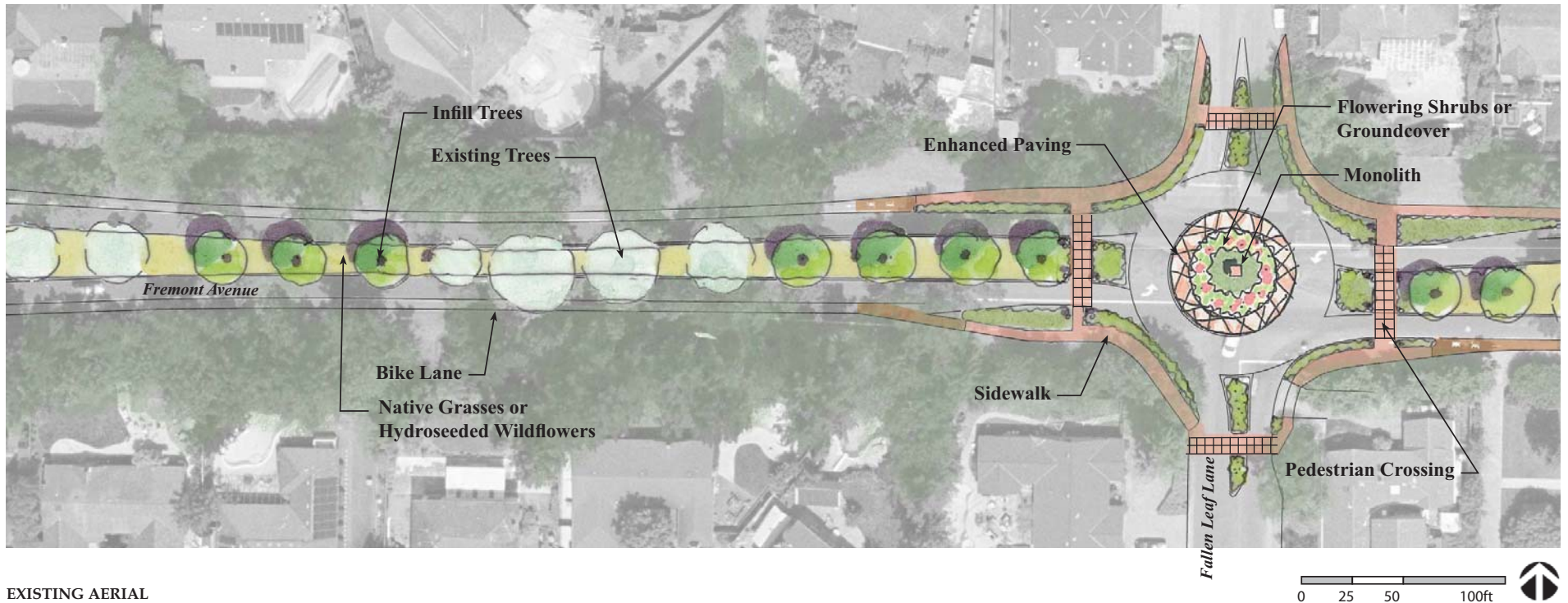

EXISTING AERIAL



LOS ALTOS COLLECTOR TRAFFIC CALMING PLAN - FREMONT AVENUE

MASTER PLAN M

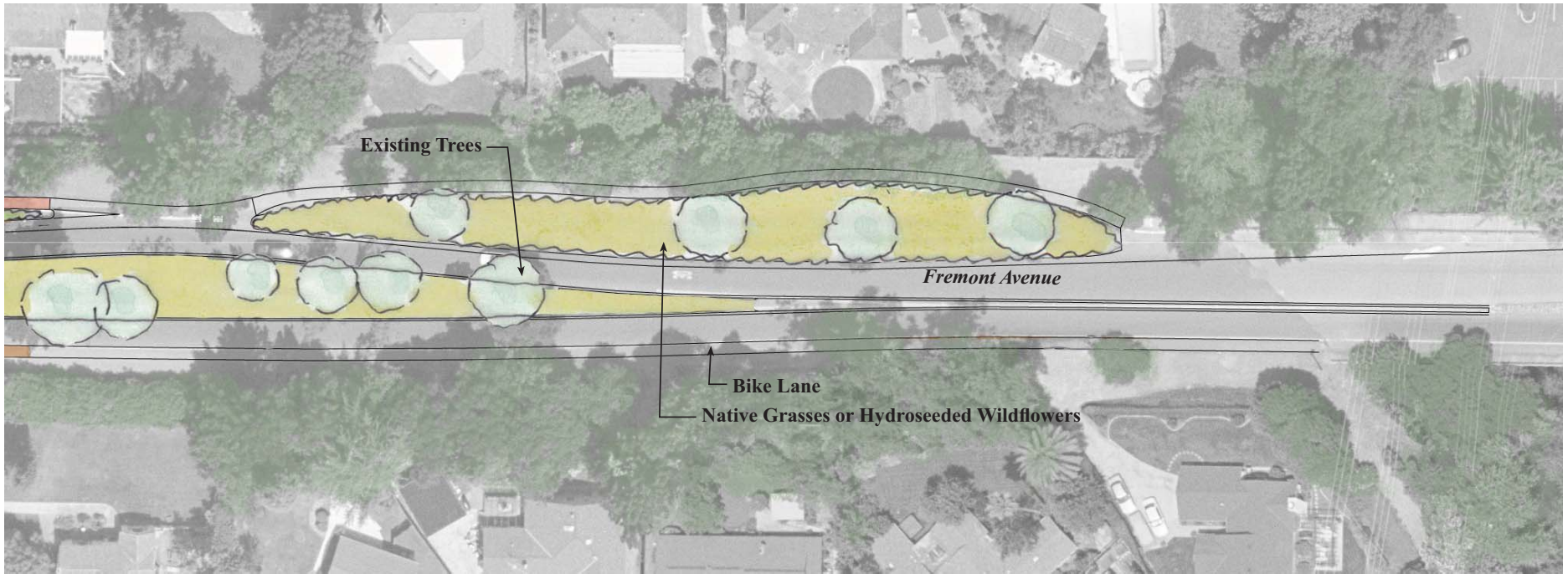

EXISTING AERIAL



PHOTO SIMULATION: FREMONT AVENUE AND TRUMAN AVENUE INTERSECTION



Proposed Traffic Calming

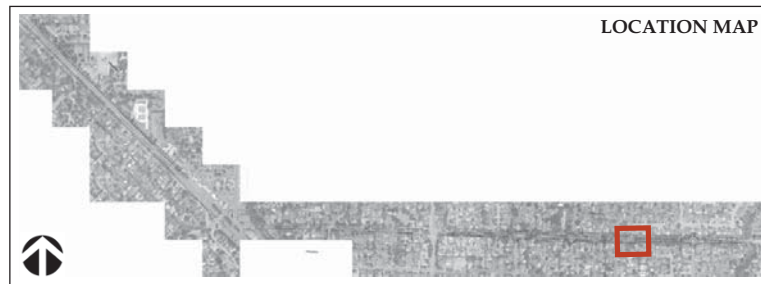

Existing Condition

OAK PRESERVATION

The Fremont Avenue project area showcases many mature oaks to create the woodland ambience. Infill trees and vegetation will reinforce the existing character. In order to successfully preserve the existing trees, appropriate grading and drainage measures have to be taken. Also, the irrigation required for the new plantings will have to be hydrozoned to be compatible with the needs of the existing trees.



The implementation of Bay-Friendly landscape features will also promote the preservation endeavor. This includes:

- Permeable paving where it occurs adjacent to existing trees.
- Diverse plantings of California native shrubs and grasses with compatible cultural needs.
- Use of mulch.



MATERIALS, FINISHES AND COLORS



BIKE RACK



POTS
Manufacturer: Dura ArtStone
Model: Round Concrete S-3-SA-36
Color: S-16
Finish: Light Sand Blast



METAL BOLLARD

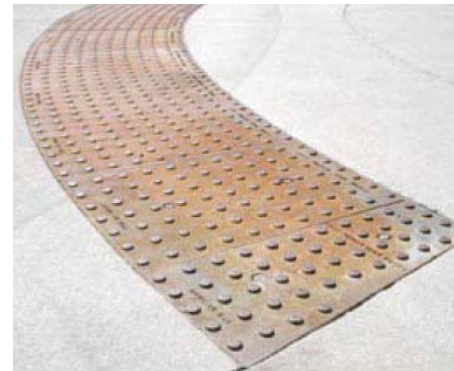

DETECTABLE WARNING SURFACE
Cast Iron with Oil Baked Finish



TRASH RECEPTACLE
Manufacturer: Victor Stanley
Model: Iron Sites Series, S42-R
Color: Powder-coated black with recycle plaque



GRANITE MONOLITH

PLANT PALETTE



Arbutus 'Marina'



Cercis occidentalis



Lagerstroemia indica



Platanus acerifolia



Prunus cerasifera



Pyrus calleryana 'Capital'

Tree Palette



Carex tumulicola



Diets vegeta



Epilobium spetentrionale



Hemerocallis hybrids

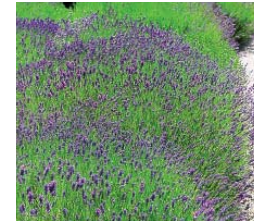

Lavandula angustifolia



Muhlenbergia rigens



Phormium 'Jack Spratt'



Phormium 'Maori Maiden'



Rosa rugosa



Salvia greggii



Wildflower mix

Shrub and Grass Palette



Appendix B

Priority Intersections

Prioritized Intersections

Project	Ranking Criteria		Nbr Bikes	Accidents ³		Weights					Street class weight	Unique intersectn geometry	Totals	Old BPAC Rank		
	Date Taken	Count Nbr Peds		Ped	Bike	Total	Peds	Bikes	School Network	Other Network					Bus Stop Locat'n	Accident weight
Miramonte @ Portland	9/29/09	20	79	0	2	2	2	4	2	2	0	3	2	0	15	
San Antonio @ W Portola	9/28/10	33	118	0	2	2	3	5	2	0	1	3	1	0	15	
Miramonte @ Covington	5/12/09	21	121	1	1	2	2	5	2	0	0	3	2	0	14	A
El Monte @ Covington/Giffen	9/23/09	81	66	0	0	0	4	4	2	2	1	0	0	0	13	B
Los Altos Av @ West Edith	9/22/09	49	42	1	0	1	4	3	2	2	0	1	0	1	13	C
Los Altos Av @ Pine	5/15/09	50	59	1	1	2	4	3	2	0	0	3	1	0	13	B
St. Joseph @ Stonehaven	10/5/11	141	50	0	0	0	4	3	2	2	0	0	1	1	13	
Springer @ El Monte ²	9/3/09	37	52	0	0	0	3	3	2	0	1	0	2	1	12	C
Almond @ N Gordon	9/10/09	96	56	0	0	0	4	3	2	0	0	0	2	0	11	A
El Monte @ Hawthorne	9/22/09	16	32	0	1	1	2	2	2	0	1	1	2	1	11	B
Los Altos Av @ W Portola	5/19/09	40	27	0	2	2	3	2	2	0	0	3	1	0	11	C
San Antonio @ Almond	9/18/09	54	25	1	3	4	4 ¹	2	2	2	1	3	1	0	11	B
San Antonio @ Lyell	9/4/09	15	12	1	0	1	1	1	2	2	1	1	3	0	11	A
Springer @ Cuesta	9/1/09	18	62	0	0	0	2	4	2	0	0	0	2	1	11	C
Homestead @ Fallen Leaf Ln	9/22/2009	3	13	0	1	1	1	1	2	2	0	1	3	0	10	
Springer @ Berry	8/31/09	31	57	0	0	0	3	3	2	0	0	0	2	0	10	C
El Monte @ University	9/24/09	27	39	0	0	0	3	2	2	0	1	0	1	0	9	C
Jardin @ Casita	9/4/09	65	30	0	0	0	4	2	2	0	0	0	0	1	9	B
Oak @ Truman	9/30/2010	55	57	0	0	0	4	3	2	0	0	0	0	0	9	
El Monte @ Cuesta	9/25/09	17	29	0	0	0	2	2	2	0	1	0	0	0	7	C
Grant Rd @ Bryant Ave	9/04/2009	9	75	0	0	0	1	4	2	0	0	0	0	0	7	
Univ. Av @ Milverton	10/15/09	4	3	0	0	0	1	1	2	2	0	0	0	0	6	
Fremont @ Truman		no counts	no counts	0	2	2			0	0	0	3	2	0	5	B
Fremont @ Fallen Leaf		no counts	no counts	0	1	1			0	0	0	1	2	0	3	C

Notes:

¹ Ped volume due to VTA bus stop for LAHS. Double weighted with bus stop weight?

² Complex intersection, needs to be recounted

³ Data from SWITRS 1/01/2000 - 3/31/2009. No SWITRS data available 4/01/2009 - 12/31/2009.



Appendix C

Intersection Level of Service Calculations

INTERSECTION SUMMARY

Site: Fremont Ave / Randolph Pkwy
AM

Fremont Ave / Randolph Parkway
AM Peak Hour
Stop (Two-Way)

Intersection Performance - Hourly Values		
Performance Measure	Vehicles	Persons
Demand Flows (Total)	1678 veh/h	2014 pers/h
Percent Heavy Vehicles	2.0 %	
Degree of Saturation	0.547	
Practical Spare Capacity	46.2 %	
Effective Intersection Capacity	3066 veh/h	
Control Delay (Total)	1.90 veh-h/h	2.29 pers-h/h
Control Delay (Average)	4.1 sec	4.1 sec
Control Delay (Worst Lane)	67.7 sec	
Control Delay (Worst Movement)	67.7 sec	67.7 sec
Geometric Delay (Average)	0.1 sec	
Stop-Line Delay (Average)	4.1 sec	
Intersection Level of Service (LOS)	NA	
95% Back of Queue - Vehicles (Worst Lane)	13.1 veh	
95% Back of Queue - Distance (Worst Lane)	333.9 ft	
Total Effective Stops	19 veh/h	22 pers/h
Effective Stop Rate	0.01 per veh	0.01 per pers
Proportion Queued	0.61	0.61
Performance Index	23.4	23.4
Travel Distance (Total)	636.7 veh-mi/h	764.0 pers-mi/h
Travel Distance (Average)	2003 ft	2003 ft
Travel Time (Total)	19.7 veh-h/h	23.7 pers-h/h
Travel Time (Average)	42.3 sec	42.3 sec
Travel Speed	32.3 mph	32.3 mph
Cost (Total)	394.95 \$/h	394.95 \$/h
Fuel Consumption (Total)	29.2 gal/h	
Carbon Dioxide (Total)	276.2 kg/h	
Hydrocarbons (Total)	0.428 kg/h	
Carbon Monoxide (Total)	18.88 kg/h	
NOx (Total)	0.656 kg/h	

Level of Service (LOS) Method: Delay (HCM 2000).
NA: Intersection LOS for Vehicles is Not Applicable for two-way sign control since the average intersection delay is not a good LOS measure due to zero delays associated with major road movements.
HCM Delay Model used. Geometric Delay not included.

Intersection Performance - Annual Values		
Performance Measure	Vehicles	Persons
Demand Flows (Total)	805,565 veh/y	966,678 pers/y
Delay	914 veh-h/y	1,097 pers-h/y
Effective Stops	8,931 veh/y	10,717 pers/y
Travel Distance	305,613 veh-mi/y	366,735 pers-mi/y
Travel Time	9,475 veh-h/y	11,370 pers-h/y
Cost	189,576 \$/y	189,576 \$/y
Fuel Consumption	13,998 gal/y	
Carbon Dioxide	132,580 kg/y	
Hydrocarbons	205 kg/y	
Carbon Monoxide	9,062 kg/y	
NOx	315 kg/y	

Processed: Wednesday, January 04, 2012 6:27:04 PM Copyright © 2000-2011 Akcelik and Associates Pty Ltd
SIDRA INTERSECTION 5.1.8.2059 www.sidrasolutions.com
Project: H:\Pdata\70100312\Traffic\Sidra\Los Altos - Fremont Corridor.sip
8000182, RBF CONSULTING, FLOATING



INTERSECTION SUMMARY

Site: Fremont Ave / Randolph Pkwy
PM

Fremont Ave / Randolph Parkway
PM Peak Hour
Stop (Two-Way)

Intersection Performance - Hourly Values		
Performance Measure	Vehicles	Persons
Demand Flows (Total)	1647 veh/h	1976 pers/h
Percent Heavy Vehicles	2.0 %	
Degree of Saturation	0.545	
Practical Spare Capacity	46.7 %	
Effective Intersection Capacity	3020 veh/h	
Control Delay (Total)	1.33 veh-h/h	1.60 pers-h/h
Control Delay (Average)	2.9 sec	2.9 sec
Control Delay (Worst Lane)	233.4 sec	
Control Delay (Worst Movement)	233.4 sec	233.4 sec
Geometric Delay (Average)	0.1 sec	
Stop-Line Delay (Average)	2.9 sec	
Intersection Level of Service (LOS)	NA	
95% Back of Queue - Vehicles (Worst Lane)	7.6 veh	
95% Back of Queue - Distance (Worst Lane)	192.8 ft	
Total Effective Stops	21 veh/h	26 pers/h
Effective Stop Rate	0.01 per veh	0.01 per pers
Proportion Queued	0.38	0.38
Performance Index	20.6	20.6
Travel Distance (Total)	624.7 veh-mi/h	749.7 pers-mi/h
Travel Distance (Average)	2003 ft	2003 ft
Travel Time (Total)	18.4 veh-h/h	22.1 pers-h/h
Travel Time (Average)	40.3 sec	40.3 sec
Travel Speed	33.9 mph	33.9 mph
Cost (Total)	361.12 \$/h	361.12 \$/h
Fuel Consumption (Total)	25.7 gal/h	
Carbon Dioxide (Total)	243.0 kg/h	
Hydrocarbons (Total)	0.360 kg/h	
Carbon Monoxide (Total)	13.55 kg/h	
NOx (Total)	0.537 kg/h	

Level of Service (LOS) Method: Delay (HCM 2000).
NA: Intersection LOS for Vehicles is Not Applicable for two-way sign control since the average intersection delay is not a good LOS measure due to zero delays associated with major road movements.
HCM Delay Model used. Geometric Delay not included.

Intersection Performance - Annual Values		
Performance Measure	Vehicles	Persons
Demand Flows (Total)	790,435 veh/y	948,522 pers/y
Delay	641 veh-h/y	769 pers-h/y
Effective Stops	10,221 veh/y	12,265 pers/y
Travel Distance	299,873 veh-mi/y	359,848 pers-mi/y
Travel Time	8,845 veh-h/y	10,614 pers-h/y
Cost	173,338 \$/y	173,338 \$/y
Fuel Consumption	12,313 gal/y	
Carbon Dioxide	116,620 kg/y	
Hydrocarbons	173 kg/y	
Carbon Monoxide	6,503 kg/y	
NOx	258 kg/y	

Processed: Wednesday, January 04, 2012 6:28:52 PM Copyright © 2000-2011 Akcelik and Associates Pty Ltd
SIDRA INTERSECTION 5.1.8.2059 www.sidrasolutions.com
Project: H:\Pdata\70100312\Traffic\Sidra\Los Altos - Fremont Corridor.sip
8000182, RBF CONSULTING, FLOATING



INTERSECTION SUMMARY

Site: Fremont Ave / Randolph Pkwy
AM

Fremont Ave / Randolph Parkway
AM Peak Hour
Roundabout

Intersection Performance - Hourly Values		
Performance Measure	Vehicles	Persons
Demand Flows (Total)	1678 veh/h	2014 pers/h
Percent Heavy Vehicles	2.0 %	
Degree of Saturation	0.666	
Practical Spare Capacity	27.6 %	
Effective Intersection Capacity	2519 veh/h	
Control Delay (Total)	3.06 veh-h/h	3.67 pers-h/h
Control Delay (Average)	6.6 sec	6.6 sec
Control Delay (Worst Lane)	15.9 sec	
Control Delay (Worst Movement)	16.9 sec	16.9 sec
Geometric Delay (Average)	6.5 sec	
Stop-Line Delay (Average)	0.1 sec	
Intersection Level of Service (LOS)	LOS A	
95% Back of Queue - Vehicles (Worst Lane)	8.9 veh	
95% Back of Queue - Distance (Worst Lane)	226.2 ft	
Total Effective Stops	816 veh/h	979 pers/h
Effective Stop Rate	0.49 per veh	0.49 per pers
Proportion Queued	0.12	0.12
Performance Index	28.4	28.4
Travel Distance (Total)	635.5 veh-mi/h	762.7 pers-mi/h
Travel Distance (Average)	2000 ft	2000 ft
Travel Time (Total)	19.2 veh-h/h	23.0 pers-h/h
Travel Time (Average)	41.2 sec	41.2 sec
Travel Speed	33.1 mph	33.1 mph
Cost (Total)	406.66 \$/h	406.66 \$/h
Fuel Consumption (Total)	30.8 gal/h	
Carbon Dioxide (Total)	291.4 kg/h	
Hydrocarbons (Total)	0.471 kg/h	
Carbon Monoxide (Total)	22.98 kg/h	
NOx (Total)	0.726 kg/h	

Level of Service (LOS) Method: Delay (HCM 2000).
Roundabout LOS Method: Same as Signalised Intersections.
Intersection LOS value for Vehicles is based on average delay for all vehicle movements.
Roundabout Capacity Model: SIDRA Standard.
SIDRA Standard Delay Model used.

Intersection Performance - Annual Values		
Performance Measure	Vehicles	Persons
Demand Flows (Total)	805,565 veh/y	966,678 pers/y
Delay	1,469 veh-h/y	1,783 pers-h/y
Effective Stops	391,738 veh/y	470,085 pers/y
Travel Distance	305,063 veh-mi/y	366,076 pers-mi/y
Travel Time	9,213 veh-h/y	11,055 pers-h/y
Cost	195,199 \$/y	195,199 \$/y
Fuel Consumption	14,767 gal/y	
Carbon Dioxide	139,860 kg/y	
Hydrocarbons	226 kg/y	
Carbon Monoxide	11,030 kg/y	
NOx	349 kg/y	

Processed: Wednesday, January 04, 2012 6:21:27 PM Copyright © 2000-2011 Akcelik and Associates Pty Ltd
SIDRA INTERSECTION 5.1.8.2059 www.sidrasolutions.com
Project: H:\Pdata\70100312\Traffic\Sidra\Los Altos - Fremont Corridor.sip

SIDRA
INTERSECTION

INTERSECTION SUMMARY

Site: Fremont Ave / Randolph Pkwy
PM

Fremont Ave / Randolph Parkway
PM Peak Hour
Roundabout

Intersection Performance - Hourly Values		
Performance Measure	Vehicles	Persons
Demand Flows (Total)	1647 veh/h	1976 pers/h
Percent Heavy Vehicles	2.0 %	
Degree of Saturation	0.647	
Practical Spare Capacity	31.4 %	
Effective Intersection Capacity	2546 veh/h	
Control Delay (Total)	2.98 veh-h/h	3.58 pers-h/h
Control Delay (Average)	6.5 sec	6.5 sec
Control Delay (Worst Lane)	19.6 sec	
Control Delay (Worst Movement)	21.9 sec	21.9 sec
Geometric Delay (Average)	6.4 sec	
Stop-Line Delay (Average)	0.1 sec	
Intersection Level of Service (LOS)	LOS A	
95% Back of Queue - Vehicles (Worst Lane)	7.1 veh	
95% Back of Queue - Distance (Worst Lane)	179.2 ft	
Total Effective Stops	824 veh/h	989 pers/h
Effective Stop Rate	0.50 per veh	0.50 per pers
Proportion Queued	0.06	0.06
Performance Index	27.4	27.4
Travel Distance (Total)	623.5 veh-mi/h	748.2 pers-mi/h
Travel Distance (Average)	1999 ft	1999 ft
Travel Time (Total)	18.7 veh-h/h	22.4 pers-h/h
Travel Time (Average)	40.8 sec	40.8 sec
Travel Speed	33.4 mph	33.4 mph
Cost (Total)	395.80 \$/h	395.80 \$/h
Fuel Consumption (Total)	29.9 gal/h	
Carbon Dioxide (Total)	283.6 kg/h	
Hydrocarbons (Total)	0.457 kg/h	
Carbon Monoxide (Total)	22.21 kg/h	
NOx (Total)	0.705 kg/h	

Level of Service (LOS) Method: Delay (HCM 2000).
Roundabout LOS Method: Same as Signalised Intersections.
Intersection LOS value for Vehicles is based on average delay for all vehicle movements.
Roundabout Capacity Model: SIDRA Standard.
SIDRA Standard Delay Model used.

Intersection Performance - Annual Values		
Performance Measure	Vehicles	Persons
Demand Flows (Total)	790,435 veh/y	948,522 pers/y
Delay	1,432 veh-h/y	1,719 pers-h/y
Effective Stops	395,586 veh/y	474,704 pers/y
Travel Distance	299,275 veh-mi/y	359,130 pers-mi/y
Travel Time	8,968 veh-h/y	10,761 pers-h/y
Cost	189,986 \$/y	189,986 \$/y
Fuel Consumption	14,372 gal/y	
Carbon Dioxide	136,117 kg/y	
Hydrocarbons	219 kg/y	
Carbon Monoxide	10,660 kg/y	
NOx	338 kg/y	

Processed: Wednesday, January 04, 2012 6:21:29 PM Copyright © 2000-2011 Akcelik and Associates Pty Ltd
SIDRA INTERSECTION 5.1.8.2059 www.sidrasolutions.com
Project: H:\Pdata\70100312\Traffic\Sidra\Los Altos - Fremont Corridor.sip

SIDRA
INTERSECTION

INTERSECTION SUMMARY

Site: Fremont Ave / Fallen Leaf Ln
AM

Fremont Ave / Fallen Leaf Ln
Stop Control - AM
Stop (Two-Way)

Intersection Performance - Hourly Values		
Performance Measure	Vehicles	Persons
Demand Flows (Total)	2543 veh/h	3052 pers/h
Percent Heavy Vehicles	2.0 %	
Degree of Saturation	2.490	
Practical Spare Capacity	-67.9 %	
Effective Intersection Capacity	1021 veh/h	
Control Delay (Total)	80.49 veh-h/h	96.59 pers-h/h
Control Delay (Average)	113.9 sec	113.9 sec
Control Delay (Worst Lane)	828.4 sec	
Control Delay (Worst Movement)	828.4 sec	828.4 sec
Level of Service (Aver. Int. Delay)	NA	
Level of Service (Worst Movement)	LOS F	
Level of Service (Worst Lane)	LOS F	
95% Back of Queue - Vehicles (Worst Lane)	39.7 veh	
95% Back of Queue - Distance (Worst Lane)	1008.2 ft	
Total Effective Stops	540 veh/h	648 pers/h
Effective Stop Rate	0.21 per veh	0.21 per pers
Proportion Queued	1.00	1.00
Performance Index	152.5	152.5
Travel Distance (Total)	899.1 veh-mi/h	1066.9 pers-mi/h
Travel Distance (Average)	1846 ft	1846 ft
Travel Time (Total)	105.3 veh-h/h	126.3 pers-h/h
Travel Time (Average)	149.0 sec	149.0 sec
Travel Speed	8.4 mph	8.4 mph
Cost (Total)	1364.45 \$/h	1364.45 \$/h
Fuel Consumption (Total)	79.6 gal/h	
Carbon Dioxide (Total)	754.1 kg/h	
Hydrocarbons (Total)	1.412 kg/h	
Carbon Monoxide (Total)	46.15 kg/h	
NOx (Total)	1.437 kg/h	

LOS (Aver. Int. Delay) for Vehicles is not applicable since the average intersection delay is not a good LOS measure for two-way sign control due to zero delays associated with major road movements.

LOS Method for individual vehicle movements and lanes: Delay (HCM).

Intersection Performance - Annual Values		
Performance Measure	Vehicles	Persons
Demand Flows (Total)	1,220,870 veh/y	1,465,044 pers/y
Delay	38,638 veh-h/y	46,365 pers-h/y
Effective Stops	259,051 veh/y	310,861 pers/y
Travel Distance	426,774 veh-mi/y	512,128 pers-mi/y
Travel Time	50,528 veh-h/y	60,634 pers-h/y
Cost	654,937 \$/y	654,937 \$/y
Fuel Consumption	38,217 gal/y	
Carbon Dioxide	361,956 kg/y	
Hydrocarbons	678 kg/y	
Carbon Monoxide	22,152 kg/y	
NOx	690 kg/y	

Processed: Thursday, January 06, 2011 6:31:19 PM
SIDRA INTERSECTION 4.0.9.973
Project: H:\Pdata\70100312\Traffic\SidraLos Altos - Fremont Corridor.sip
8000182, RBF CONSULTING, FLOATING

Copyright ©2000-2009 Akcelik & Associates Pty Ltd
www.sidrasolutions.com



INTERSECTION SUMMARY

Site: Fremont Ave / Fallen Leaf Ln
PM

Fremont Ave / Fallen Leaf Ln
Stop Control - PM
Stop (Two-Way)

Intersection Performance - Hourly Values		
Performance Measure	Vehicles	Persons
Demand Flows (Total)	2079 veh/h	2495 pers/h
Percent Heavy Vehicles	2.0 %	
Degree of Saturation	1.630	
Practical Spare Capacity	-50.9 %	
Effective Intersection Capacity	1275 veh/h	
Control Delay (Total)	28.15 veh-h/h	33.78 pers-h/h
Control Delay (Average)	48.7 sec	48.7 sec
Control Delay (Worst Lane)	423.8 sec	
Control Delay (Worst Movement)	423.8 sec	423.8 sec
Level of Service (Aver. Int. Delay)	NA	
Level of Service (Worst Movement)	LOS F	
Level of Service (Worst Lane)	LOS F	
95% Back of Queue - Vehicles (Worst Lane)	21.2 veh	
95% Back of Queue - Distance (Worst Lane)	538.9 ft	
Total Effective Stops	315 veh/h	377 pers/h
Effective Stop Rate	0.15 per veh	0.15 per pers
Proportion Queued	1.00	1.00
Performance Index	70.2	70.2
Travel Distance (Total)	725.0 veh-mi/h	870.0 pers-mi/h
Travel Distance (Average)	1841 ft	1841 ft
Travel Time (Total)	48.4 veh-h/h	58.0 pers-h/h
Travel Time (Average)	83.7 sec	83.7 sec
Travel Speed	15.0 mph	15.0 mph
Cost (Total)	701.42 \$/h	701.42 \$/h
Fuel Consumption (Total)	51.2 gal/h	
Carbon Dioxide (Total)	485.3 kg/h	
Hydrocarbons (Total)	0.849 kg/h	
Carbon Monoxide (Total)	35.53 kg/h	
NOx (Total)	1.094 kg/h	

LOS (Aver. Int. Delay) for Vehicles is not applicable since the average intersection delay is not a good LOS measure for two-way sign control due to zero delays associated with major road movements.

LOS Method for individual vehicle movements and lanes: Delay (HCM).

Intersection Performance - Annual Values		
Performance Measure	Vehicles	Persons
Demand Flows (Total)	998,087 veh/y	1,197,704 pers/y
Delay	13,510 veh-h/y	16,212 pers-h/y
Effective Stops	150,983 veh/y	181,180 pers/y
Travel Distance	348,003 veh-mi/y	417,604 pers-mi/y
Travel Time	23,209 veh-h/y	27,850 pers-h/y
Cost	336,681 \$/y	336,681 \$/y
Fuel Consumption	24,594 gal/y	
Carbon Dioxide	232,929 kg/y	
Hydrocarbons	407 kg/y	
Carbon Monoxide	17,054 kg/y	
NOx	525 kg/y	

Processed: Thursday, January 06, 2011 6:31:19 PM
SIDRA INTERSECTION 4.0.9.973
Project: H:\Pdata\70100312\Traffic\SidraLos Altos - Fremont Corridor.sip
8000182, RBF CONSULTING, FLOATING

Copyright ©2000-2009 Akcelik & Associates Pty Ltd
www.sidrasolutions.com



INTERSECTION SUMMARY

Site: Fremont Ave / Fallen Leaf Ln
AM

Fremont Ave / Fallen Leaf Ln
RAB - AM
Roundabout

Intersection Performance - Hourly Values

Performance Measure	Vehicles	Persons
Demand Flows (Total)	2543 veh/h	3052 pers/h
Percent Heavy Vehicles	2.0 %	
Degree of Saturation	0.916	
Practical Spare Capacity	-7.3 %	
Effective Intersection Capacity	2775 veh/h	
Control Delay (Total)	5.44 veh-h/h	6.53 pers-h/h
Control Delay (Average)	7.7 sec	7.7 sec
Control Delay (Worst Lane)	31.3 sec	
Control Delay (Worst Movement)	32.7 sec	32.7 sec
Level of Service (Aver. Int. Delay)	LOS A	
Level of Service (Worst Movement)	LOS C	
Level of Service (Worst Lane)	LOS C	
95% Back of Queue - Vehicles (Worst Lane)	39.4 veh	
95% Back of Queue - Distance (Worst Lane)	999.9 ft	
Total Effective Stops	1179 veh/h	1414 pers/h
Effective Stop Rate	0.46 per veh	0.46 per pers
Proportion Queued	0.66	0.66
Performance Index	57.1	57.1
Travel Distance (Total)	973.3 veh-mi/h	1167.9 pers-mi/h
Travel Distance (Average)	2020 ft	2020 ft
Travel Time (Total)	31.8 veh-h/h	38.2 pers-h/h
Travel Time (Average)	45.1 sec	45.1 sec
Travel Speed	30.6 mph	30.6 mph
Cost (Total)	539.29 \$/h	539.29 \$/h
Fuel Consumption (Total)	49.1 gal/h	
Carbon Dioxide (Total)	465.4 kg/h	
Hydrocarbons (Total)	0.759 kg/h	
Carbon Monoxide (Total)	36.99 kg/h	
NOx (Total)	1.156 kg/h	

LOS (Aver. Int. Delay) for Vehicles is based on average delay for all vehicle movements. LOS Method: Delay (HCM).
LOS Method for individual vehicle movements and lanes: Delay (HCM).
Roundabout LOS Method: Same as Signalised Intersections.
Roundabout Capacity Model: SIDRA Standard.

Intersection Performance - Annual Values

Performance Measure	Vehicles	Persons
Demand Flows (Total)	1,220,870 veh/y	1,465,044 pers/y
Delay	2,611 veh-h/y	3,133 pers-h/y
Effective Stops	565,730 veh/y	678,876 pers/y
Travel Distance	467,173 veh-mi/y	560,607 pers-mi/y
Travel Time	15,287 veh-h/y	18,345 pers-h/y
Cost	258,860 \$/y	258,860 \$/y
Fuel Consumption	23,588 gal/y	
Carbon Dioxide	223,407 kg/y	
Hydrocarbons	364 kg/y	
Carbon Monoxide	17,754 kg/y	
NOx	555 kg/y	

Processed: Thursday, January 06, 2011 6:19:56 PM Copyright ©2000-2009 Akcelik & Associates Pty Ltd
SIDRA INTERSECTION 4.0.9.973 www.sidrasolutions.com
Project: H:\Pdata\70100312\Traffic\Sidra\Los Altos - Fremont Corridor.sip
8000182, RBF CONSULTING, FLOATING



INTERSECTION SUMMARY

Site: Fremont Ave / Fallen Leaf Ln
PM

Fremont Ave / Fallen Leaf Ln
RAB - PM
Roundabout

Intersection Performance - Hourly Values

Performance Measure	Vehicles	Persons
Demand Flows (Total)	2079 veh/h	2495 pers/h
Percent Heavy Vehicles	2.0 %	
Degree of Saturation	0.906	
Practical Spare Capacity	-6.2 %	
Effective Intersection Capacity	2296 veh/h	
Control Delay (Total)	4.77 veh-h/h	5.72 pers-h/h
Control Delay (Average)	8.3 sec	8.3 sec
Control Delay (Worst Lane)	19.3 sec	
Control Delay (Worst Movement)	24.7 sec	24.7 sec
Level of Service (Aver. Int. Delay)	LOS A	
Level of Service (Worst Movement)	LOS C	
Level of Service (Worst Lane)	LOS B	
95% Back of Queue - Vehicles (Worst Lane)	19.2 veh	
95% Back of Queue - Distance (Worst Lane)	487.6 ft	
Total Effective Stops	1164 veh/h	1397 pers/h
Effective Stop Rate	0.56 per veh	0.56 per pers
Proportion Queued	0.65	0.65
Performance Index	41.6	41.6
Travel Distance (Total)	796.6 veh-mi/h	955.9 pers-mi/h
Travel Distance (Average)	2023 ft	2023 ft
Travel Time (Total)	25.8 veh-h/h	31.0 pers-h/h
Travel Time (Average)	44.7 sec	44.7 sec
Travel Speed	30.8 mph	30.8 mph
Cost (Total)	438.64 \$/h	438.64 \$/h
Fuel Consumption (Total)	40.1 gal/h	
Carbon Dioxide (Total)	379.9 kg/h	
Hydrocarbons (Total)	0.619 kg/h	
Carbon Monoxide (Total)	30.25 kg/h	
NOx (Total)	0.945 kg/h	

LOS (Aver. Int. Delay) for Vehicles is based on average delay for all vehicle movements. LOS Method: Delay (HCM).
LOS Method for individual vehicle movements and lanes: Delay (HCM).
Roundabout LOS Method: Same as Signalised Intersections.
Roundabout Capacity Model: SIDRA Standard.

Intersection Performance - Annual Values

Performance Measure	Vehicles	Persons
Demand Flows (Total)	998,087 veh/y	1,197,704 pers/y
Delay	2,288 veh-h/y	2,746 pers-h/y
Effective Stops	558,740 veh/y	670,488 pers/y
Travel Distance	382,374 veh-mi/y	458,849 pers-mi/y
Travel Time	12,399 veh-h/y	14,879 pers-h/y
Cost	210,548 \$/y	210,548 \$/y
Fuel Consumption	19,255 gal/y	
Carbon Dioxide	182,363 kg/y	
Hydrocarbons	297 kg/y	
Carbon Monoxide	14,521 kg/y	
NOx	454 kg/y	

Processed: Thursday, January 06, 2011 6:19:56 PM Copyright ©2000-2009 Akcelik & Associates Pty Ltd
SIDRA INTERSECTION 4.0.9.973 www.sidrasolutions.com
Project: H:\Pdata\70100312\Traffic\Sidra\Los Altos - Fremont Corridor.sip
8000182, RBF CONSULTING, FLOATING



INTERSECTION SUMMARY

Site: Fremont Ave / Newcastle Dr
AM

Fremont Ave / Newcastle Dr
2WS - AM
Stop (Two-Way)

Intersection Performance - Hourly Values

Performance Measure	Vehicles	Persons
Demand Flows (Total)	1890 veh/h	2268 pers/h
Percent Heavy Vehicles	2.0 %	
Degree of Saturation	1.087	
Practical Spare Capacity	-26.4 %	
Effective Intersection Capacity	1739 veh/h	
Control Delay (Total)	9.97 veh-h/h	11.97 pers-h/h
Control Delay (Average)	19.0 sec	19.0 sec
Control Delay (Worst Lane)	239.5 sec	
Control Delay (Worst Movement)	239.5 sec	239.5 sec
Level of Service (Aver. Int. Delay)	NA	
Level of Service (Worst Movement)	LOS F	
Level of Service (Worst Lane)	LOS F	
95% Back of Queue - Vehicles (Worst Lane)	17.0 veh	
95% Back of Queue - Distance (Worst Lane)	433.0 ft	
Total Effective Stops	265 veh/h	318 pers/h
Effective Stop Rate	0.14 per veh	0.14 per pers
Proportion Queued	0.63	0.63
Performance Index	37.0	37.0
Travel Distance (Total)	656.4 veh-mi/h	787.7 pers-mi/h
Travel Distance (Average)	1834 ft	1834 ft
Travel Time (Total)	27.6 veh-h/h	33.1 pers-h/h
Travel Time (Average)	52.5 sec	52.5 sec
Travel Speed	23.8 mph	23.8 mph
Cost (Total)	429.53 \$/h	429.53 \$/h
Fuel Consumption (Total)	35.0 gal/h	
Carbon Dioxide (Total)	331.7 kg/h	
Hydrocarbons (Total)	0.535 kg/h	
Carbon Monoxide (Total)	22.18 kg/h	
NOx (Total)	0.755 kg/h	

LOS (Aver. Int. Delay) for Vehicles is not applicable since the average intersection delay is not a good LOS measure for two-way sign control due to zero delays associated with major road movements.

LOS Method for individual vehicle movements and lanes: Delay (HCM).

Intersection Performance - Annual Values

Performance Measure	Vehicles	Persons
Demand Flows (Total)	907,304 veh/y	1,088,765 pers/y
Delay	4,787 veh-h/y	5,744 pers-h/y
Effective Stops	127,216 veh/y	152,659 pers/y
Travel Distance	315,087 veh-mi/y	378,105 pers-mi/y
Travel Time	13,234 veh-h/y	15,881 pers-h/y
Cost	206,175 \$/y	206,175 \$/y
Fuel Consumption	16,812 gal/y	
Carbon Dioxide	159,227 kg/y	
Hydrocarbons	257 kg/y	
Carbon Monoxide	10,645 kg/y	
NOx	363 kg/y	

Processed: Thursday, January 06, 2011 6:31:17 PM
SIDRA INTERSECTION 4.0.9.973
Project: H:\Pdata\70100312\Traffic\SidraLos Altos - Fremont Corridor.sip
8000182, RBF CONSULTING, FLOATING

SIDRA
INTERSECTION

INTERSECTION SUMMARY

Site: Fremont Ave / Newcastle Dr
PM

Fremont Ave / Newcastle Dr
2WS - PM
Stop (Two-Way)

Intersection Performance - Hourly Values

Performance Measure	Vehicles	Persons
Demand Flows (Total)	1707 veh/h	2048 pers/h
Percent Heavy Vehicles	2.0 %	
Degree of Saturation	0.999	
Practical Spare Capacity	-19.9 %	
Effective Intersection Capacity	1709 veh/h	
Control Delay (Total)	7.07 veh-h/h	8.48 pers-h/h
Control Delay (Average)	14.9 sec	14.9 sec
Control Delay (Worst Lane)	276.4 sec	
Control Delay (Worst Movement)	276.4 sec	276.4 sec
Level of Service (Aver. Int. Delay)	NA	
Level of Service (Worst Movement)	LOS F	
Level of Service (Worst Lane)	LOS F	
95% Back of Queue - Vehicles (Worst Lane)	10.2 veh	
95% Back of Queue - Distance (Worst Lane)	259.4 ft	
Total Effective Stops	148 veh/h	178 pers/h
Effective Stop Rate	0.09 per veh	0.09 per pers
Proportion Queued	0.42	0.42
Performance Index	28.3	28.3
Travel Distance (Total)	592.0 veh-mi/h	710.3 pers-mi/h
Travel Distance (Average)	1832 ft	1832 ft
Travel Time (Total)	22.6 veh-h/h	27.1 pers-h/h
Travel Time (Average)	47.7 sec	47.7 sec
Travel Speed	26.2 mph	26.2 mph
Cost (Total)	347.23 \$/h	347.23 \$/h
Fuel Consumption (Total)	27.8 gal/h	
Carbon Dioxide (Total)	263.6 kg/h	
Hydrocarbons (Total)	0.409 kg/h	
Carbon Monoxide (Total)	15.01 kg/h	
NOx (Total)	0.568 kg/h	

LOS (Aver. Int. Delay) for Vehicles is not applicable since the average intersection delay is not a good LOS measure for two-way sign control due to zero delays associated with major road movements.

LOS Method for individual vehicle movements and lanes: Delay (HCM).

Intersection Performance - Annual Values

Performance Measure	Vehicles	Persons
Demand Flows (Total)	819,130 veh/y	982,957 pers/y
Delay	3,392 veh-h/y	4,070 pers-h/y
Effective Stops	71,188 veh/y	85,426 pers/y
Travel Distance	284,138 veh-mi/y	340,966 pers-mi/y
Travel Time	10,844 veh-h/y	13,012 pers-h/y
Cost	166,668 \$/y	166,668 \$/y
Fuel Consumption	13,358 gal/y	
Carbon Dioxide	126,510 kg/y	
Hydrocarbons	196 kg/y	
Carbon Monoxide	7,205 kg/y	
NOx	273 kg/y	

Processed: Thursday, January 06, 2011 6:31:18 PM
SIDRA INTERSECTION 4.0.9.973
Project: H:\Pdata\70100312\Traffic\SidraLos Altos - Fremont Corridor.sip
8000182, RBF CONSULTING, FLOATING

SIDRA
INTERSECTION

INTERSECTION SUMMARY

Site: Fremont Ave / Newcastle Dr
AM

Fremont Ave / Newcastle Dr
RAB - AM
Roundabout

Intersection Performance - Hourly Values		
Performance Measure	Vehicles	Persons
Demand Flows (Total)	1890 veh/h	2268 pers/h
Percent Heavy Vehicles	2.0 %	
Degree of Saturation	0.760	
Practical Spare Capacity	11.9 %	
Effective Intersection Capacity	2488 veh/h	
Control Delay (Total)	3.31 veh-h/h	3.97 pers-h/h
Control Delay (Average)	6.3 sec	6.3 sec
Control Delay (Worst Lane)	12.3 sec	
Control Delay (Worst Movement)	17.6 sec	17.6 sec
Level of Service (Aver. Int. Delay)	LOS A	
Level of Service (Worst Movement)	LOS B	
Level of Service (Worst Lane)	LOS B	
95% Back of Queue - Vehicles (Worst Lane)	13.7 veh	
95% Back of Queue - Distance (Worst Lane)	346.8 ft	
Total Effective Stops	881 veh/h	1057 pers/h
Effective Stop Rate	0.47 per veh	0.47 per pers
Proportion Queued	0.30	0.30
Performance Index	33.4	33.4
Travel Distance (Total)	725.2 veh-mi/h	870.3 pers-mi/h
Travel Distance (Average)	2026 ft	2026 ft
Travel Time (Total)	22.2 veh-h/h	26.6 pers-h/h
Travel Time (Average)	42.2 sec	42.2 sec
Travel Speed	32.7 mph	32.7 mph
Cost (Total)	371.47 \$/h	371.47 \$/h
Fuel Consumption (Total)	33.6 gal/h	
Carbon Dioxide (Total)	318.5 kg/h	
Hydrocarbons (Total)	0.507 kg/h	
Carbon Monoxide (Total)	23.54 kg/h	
NOx (Total)	0.766 kg/h	

LOS (Aver. Int. Delay) for Vehicles is based on average delay for all vehicle movements. LOS Method: Delay (HCM).
LOS Method for individual vehicle movements and lanes: Delay (HCM).
Roundabout LOS Method: Same as Signalised Intersections.
Roundabout Capacity Model: SIDRA Standard.

Intersection Performance - Annual Values		
Performance Measure	Vehicles	Persons
Demand Flows (Total)	907,304 veh/y	1,088,765 pers/y
Delay	1,587 veh-h/y	1,904 pers-h/y
Effective Stops	422,687 veh/y	507,224 pers/y
Travel Distance	348,112 veh-mi/y	417,734 pers-mi/y
Travel Time	10,634 veh-h/y	12,761 pers-h/y
Cost	178,303 \$/y	178,303 \$/y
Fuel Consumption	16,140 gal/y	
Carbon Dioxide	152,865 kg/y	
Hydrocarbons	243 kg/y	
Carbon Monoxide	11,299 kg/y	
NOx	368 kg/y	

Processed: Thursday, January 06, 2011 6:19:55 PM Copyright ©2000-2009 Akcelik & Associates Pty Ltd
SIDRA INTERSECTION 4.0.9.973 www.sidrasolutions.com
Project: H:\Pdata\70100312\Traffic\Sidra\Los Altos - Fremont Corridor.sip
8000182, RBF CONSULTING, FLOATING



INTERSECTION SUMMARY

Site: Fremont Ave / Newcastle Dr
PM

Fremont Ave / Newcastle Dr
RAB - PM
Roundabout

Intersection Performance - Hourly Values		
Performance Measure	Vehicles	Persons
Demand Flows (Total)	1707 veh/h	2048 pers/h
Percent Heavy Vehicles	2.0 %	
Degree of Saturation	0.713	
Practical Spare Capacity	19.2 %	
Effective Intersection Capacity	2392 veh/h	
Control Delay (Total)	2.82 veh-h/h	3.38 pers-h/h
Control Delay (Average)	5.9 sec	5.9 sec
Control Delay (Worst Lane)	15.9 sec	
Control Delay (Worst Movement)	21.0 sec	21.0 sec
Level of Service (Aver. Int. Delay)	LOS A	
Level of Service (Worst Movement)	LOS C	
Level of Service (Worst Lane)	LOS B	
95% Back of Queue - Vehicles (Worst Lane)	9.9 veh	
95% Back of Queue - Distance (Worst Lane)	252.4 ft	
Total Effective Stops	737 veh/h	884 pers/h
Effective Stop Rate	0.43 per veh	0.43 per pers
Proportion Queued	0.29	0.29
Performance Index	28.4	28.4
Travel Distance (Total)	652.3 veh-mi/h	782.8 pers-mi/h
Travel Distance (Average)	2018 ft	2018 ft
Travel Time (Total)	19.8 veh-h/h	23.8 pers-h/h
Travel Time (Average)	41.8 sec	41.8 sec
Travel Speed	32.9 mph	32.9 mph
Cost (Total)	332.35 \$/h	332.35 \$/h
Fuel Consumption (Total)	30.1 gal/h	
Carbon Dioxide (Total)	285.1 kg/h	
Hydrocarbons (Total)	0.453 kg/h	
Carbon Monoxide (Total)	20.94 kg/h	
NOx (Total)	0.685 kg/h	

LOS (Aver. Int. Delay) for Vehicles is based on average delay for all vehicle movements. LOS Method: Delay (HCM).
LOS Method for individual vehicle movements and lanes: Delay (HCM).
Roundabout LOS Method: Same as Signalised Intersections.
Roundabout Capacity Model: SIDRA Standard.

Intersection Performance - Annual Values		
Performance Measure	Vehicles	Persons
Demand Flows (Total)	819,130 veh/y	982,957 pers/y
Delay	1,352 veh-h/y	1,622 pers-h/y
Effective Stops	353,792 veh/y	424,551 pers/y
Travel Distance	313,107 veh-mi/y	375,728 pers-mi/y
Travel Time	9,509 veh-h/y	11,411 pers-h/y
Cost	159,527 \$/y	159,527 \$/y
Fuel Consumption	14,447 gal/y	
Carbon Dioxide	136,832 kg/y	
Hydrocarbons	217 kg/y	
Carbon Monoxide	10,052 kg/y	
NOx	329 kg/y	

Processed: Thursday, January 06, 2011 6:19:55 PM Copyright ©2000-2009 Akcelik & Associates Pty Ltd
SIDRA INTERSECTION 4.0.9.973 www.sidrasolutions.com
Project: H:\Pdata\70100312\Traffic\Sidra\Los Altos - Fremont Corridor.sip
8000182, RBF CONSULTING, FLOATING



INTERSECTION SUMMARY

Site: Fremont Ave / Truman Ave
AM

Fremont Ave / Truman Ave
Stop Control - AM
Stop (Two-Way)

Intersection Performance - Hourly Values		
Performance Measure	Vehicles	Persons
Demand Flows (Total)	2360 veh/h	2832 pers/h
Percent Heavy Vehicles	2.0 %	
Degree of Saturation	5.051	
Practical Spare Capacity	-84.2 %	
Effective Intersection Capacity	467 veh/h	
Control Delay (Total)	180.71 veh-h/h	216.86 pers-h/h
Control Delay (Average)	275.7 sec	275.7 sec
Control Delay (Worst Lane)	1953.3 sec	
Control Delay (Worst Movement)	1953.3 sec	1953.3 sec
Level of Service (Aver. Int. Delay)	NA	
Level of Service (Worst Movement)	LOS F	
Level of Service (Worst Lane)	LOS F	
95% Back of Queue - Vehicles (Worst Lane)	94.1 veh	
95% Back of Queue - Distance (Worst Lane)	2389.8 ft	
Total Effective Stops	1203 veh/h	1444 pers/h
Effective Stop Rate	0.51 per veh	0.51 per pers
Proportion Queued	0.47	0.47
Performance Index	253.3	253.3
Travel Distance (Total)	830.3 veh-mi/h	996.4 pers-mi/h
Travel Distance (Average)	1858 ft	1858 ft
Travel Time (Total)	202.7 veh-h/h	243.2 pers-h/h
Travel Time (Average)	309.2 sec	309.2 sec
Travel Speed	4.1 mph	4.1 mph
Cost (Total)	2374.41 \$/h	2374.41 \$/h
Fuel Consumption (Total)	104.0 gal/h	
Carbon Dioxide (Total)	984.8 kg/h	
Hydrocarbons (Total)	2.008 kg/h	
Carbon Monoxide (Total)	35.45 kg/h	
NOx (Total)	1.246 kg/h	

LOS (Aver. Int. Delay) for Vehicles is not applicable since the average intersection delay is not a good LOS measure for two-way sign control due to zero delays associated with major road movements.

LOS Method for individual vehicle movements and lanes: Delay (HCM).

Intersection Performance - Annual Values		
Performance Measure	Vehicles	Persons
Demand Flows (Total)	1,132,696 veh/y	1,359,235 pers/y
Delay	86,743 veh-h/y	104,091 pers-h/y
Effective Stops	577,453 veh/y	692,943 pers/y
Travel Distance	398,549 veh-mi/y	478,259 pers-mi/y
Travel Time	97,275 veh-h/y	116,730 pers-h/y
Cost	1,139,718 \$/y	1,139,718 \$/y
Fuel Consumption	49,909 gal/y	
Carbon Dioxide	472,688 kg/y	
Hydrocarbons	964 kg/y	
Carbon Monoxide	17,015 kg/y	
NOx	598 kg/y	

Processed: Thursday, January 06, 2011 6:31:18 PM
SIDRA INTERSECTION 4.0.9.973
Project: H:\Pdata\70100312\Traffic\SidraLos Altos - Fremont Corridor.sip
8000182, RBF CONSULTING, FLOATING



INTERSECTION SUMMARY

Site: Fremont Ave / Truman Ave
PM

Fremont Ave / Truman Ave
Stop Control - PM
Stop (Two-Way)

Intersection Performance - Hourly Values		
Performance Measure	Vehicles	Persons
Demand Flows (Total)	1929 veh/h	2315 pers/h
Percent Heavy Vehicles	2.0 %	
Degree of Saturation	2.122	
Practical Spare Capacity	-62.3 %	
Effective Intersection Capacity	909 veh/h	
Control Delay (Total)	32.20 veh-h/h	38.63 pers-h/h
Control Delay (Average)	60.1 sec	60.1 sec
Control Delay (Worst Lane)	626.9 sec	
Control Delay (Worst Movement)	626.9 sec	626.9 sec
Level of Service (Aver. Int. Delay)	NA	
Level of Service (Worst Movement)	LOS F	
Level of Service (Worst Lane)	LOS F	
95% Back of Queue - Vehicles (Worst Lane)	38.0 veh	
95% Back of Queue - Distance (Worst Lane)	966.4 ft	
Total Effective Stops	624 veh/h	748 pers/h
Effective Stop Rate	0.32 per veh	0.32 per pers
Proportion Queued	0.61	0.61
Performance Index	72.0	72.0
Travel Distance (Total)	673.9 veh-mi/h	808.7 pers-mi/h
Travel Distance (Average)	1844 ft	1844 ft
Travel Time (Total)	50.3 veh-h/h	60.3 pers-h/h
Travel Time (Average)	93.8 sec	93.8 sec
Travel Speed	13.4 mph	13.4 mph
Cost (Total)	684.16 \$/h	684.16 \$/h
Fuel Consumption (Total)	44.4 gal/h	
Carbon Dioxide (Total)	420.4 kg/h	
Hydrocarbons (Total)	0.739 kg/h	
Carbon Monoxide (Total)	25.08 kg/h	
NOx (Total)	0.837 kg/h	

LOS (Aver. Int. Delay) for Vehicles is not applicable since the average intersection delay is not a good LOS measure for two-way sign control due to zero delays associated with major road movements.

LOS Method for individual vehicle movements and lanes: Delay (HCM).

Intersection Performance - Annual Values		
Performance Measure	Vehicles	Persons
Demand Flows (Total)	926,087 veh/y	1,111,304 pers/y
Delay	15,454 veh-h/y	18,545 pers-h/y
Effective Stops	299,328 veh/y	359,194 pers/y
Travel Distance	323,494 veh-mi/y	388,193 pers-mi/y
Travel Time	24,137 veh-h/y	28,964 pers-h/y
Cost	328,398 \$/y	328,398 \$/y
Fuel Consumption	21,307 gal/y	
Carbon Dioxide	201,800 kg/y	
Hydrocarbons	355 kg/y	
Carbon Monoxide	12,037 kg/y	
NOx	402 kg/y	

Processed: Thursday, January 06, 2011 6:31:18 PM
SIDRA INTERSECTION 4.0.9.973
Project: H:\Pdata\70100312\Traffic\SidraLos Altos - Fremont Corridor.sip
8000182, RBF CONSULTING, FLOATING



INTERSECTION SUMMARY

Site: Fremont Ave / Truman Ave
AM

Fremont Ave / Truman Ave
RAB - AM
Roundabout

Intersection Performance - Hourly Values		
Performance Measure	Vehicles	Persons
Demand Flows (Total)	2360 veh/h	2832 pers/h
Percent Heavy Vehicles	2.0 %	
Degree of Saturation	0.893	
Practical Spare Capacity	-4.9 %	
Effective Intersection Capacity	2642 veh/h	
Control Delay (Total)	7.46 veh-h/h	8.95 pers-h/h
Control Delay (Average)	11.4 sec	11.4 sec
Control Delay (Worst Lane)	41.9 sec	
Control Delay (Worst Movement)	45.4 sec	45.4 sec
Level of Service (Aver. Int. Delay)	LOS B	
Level of Service (Worst Movement)	LOS D	
Level of Service (Worst Lane)	LOS D	
95% Back of Queue - Vehicles (Worst Lane)	26.2 veh	
95% Back of Queue - Distance (Worst Lane)	666.6 ft	
Total Effective Stops	1413 veh/h	1695 pers/h
Effective Stop Rate	0.60 per veh	0.60 per pers
Proportion Queued	0.82	0.82
Performance Index	55.2	55.2
Travel Distance (Total)	904.7 veh-mi/h	1085.7 pers-mi/h
Travel Distance (Average)	2024 ft	2024 ft
Travel Time (Total)	32.2 veh-h/h	38.7 pers-h/h
Travel Time (Average)	49.2 sec	49.2 sec
Travel Speed	28.1 mph	28.1 mph
Cost (Total)	538.76 \$/h	538.76 \$/h
Fuel Consumption (Total)	48.2 gal/h	
Carbon Dioxide (Total)	456.3 kg/h	
Hydrocarbons (Total)	0.757 kg/h	
Carbon Monoxide (Total)	37.11 kg/h	
NOx (Total)	1.138 kg/h	

LOS (Aver. Int. Delay) for Vehicles is based on average delay for all vehicle movements. LOS Method: Delay (HCM).
LOS Method for individual vehicle movements and lanes: Delay (HCM).
Roundabout LOS Method: Same as Signalised Intersections.
Roundabout Capacity Model: SIDRA Standard.

Intersection Performance - Annual Values		
Performance Measure	Vehicles	Persons
Demand Flows (Total)	1,132,696 veh/y	1,359,235 pers/y
Delay	3,579 veh-h/y	4,295 pers-h/y
Effective Stops	678,152 veh-h/y	813,782 pers-h/y
Travel Distance	434,272 veh-mi/y	521,126 pers-mi/y
Travel Time	15,474 veh-h/y	18,568 pers-h/y
Cost	258,604 \$/y	258,604 \$/y
Fuel Consumption	23,124 gal/y	
Carbon Dioxide	219,013 kg/y	
Hydrocarbons	363 kg/y	
Carbon Monoxide	17,815 kg/y	
NOx	546 kg/y	

Processed: Thursday, January 06, 2011 6:19:55 PM Copyright ©2000-2009 Akcelik & Associates Pty Ltd
SIDRA INTERSECTION 4.0.9.973 www.sidrasolutions.com
Project: H:\Pdata\70100312\Traffic\Sidra\Los Altos - Fremont Corridor.sip
8000182, RBF CONSULTING, FLOATING

SIDRA
INTERSECTION

INTERSECTION SUMMARY

Site: Fremont Ave / Truman Ave
PM

Fremont Ave / Truman Ave
RAB - PM
Roundabout

Intersection Performance - Hourly Values		
Performance Measure	Vehicles	Persons
Demand Flows (Total)	1929 veh/h	2315 pers/h
Percent Heavy Vehicles	2.0 %	
Degree of Saturation	0.827	
Practical Spare Capacity	2.8 %	
Effective Intersection Capacity	2333 veh/h	
Control Delay (Total)	3.88 veh-h/h	4.65 pers-h/h
Control Delay (Average)	7.2 sec	7.2 sec
Control Delay (Worst Lane)	15.0 sec	
Control Delay (Worst Movement)	16.8 sec	16.8 sec
Level of Service (Aver. Int. Delay)	LOS A	
Level of Service (Worst Movement)	LOS B	
Level of Service (Worst Lane)	LOS B	
95% Back of Queue - Vehicles (Worst Lane)	15.1 veh	
95% Back of Queue - Distance (Worst Lane)	384.6 ft	
Total Effective Stops	1023 veh/h	1227 pers/h
Effective Stop Rate	0.53 per veh	0.53 per pers
Proportion Queued	0.62	0.62
Performance Index	36.1	36.1
Travel Distance (Total)	739.9 veh-mi/h	887.9 pers-mi/h
Travel Distance (Average)	2025 ft	2025 ft
Travel Time (Total)	23.8 veh-h/h	28.5 pers-h/h
Travel Time (Average)	44.3 sec	44.3 sec
Travel Speed	31.2 mph	31.2 mph
Cost (Total)	403.49 \$/h	403.49 \$/h
Fuel Consumption (Total)	36.9 gal/h	
Carbon Dioxide (Total)	349.8 kg/h	
Hydrocarbons (Total)	0.569 kg/h	
Carbon Monoxide (Total)	27.70 kg/h	
NOx (Total)	0.868 kg/h	

LOS (Aver. Int. Delay) for Vehicles is based on average delay for all vehicle movements. LOS Method: Delay (HCM).
LOS Method for individual vehicle movements and lanes: Delay (HCM).
Roundabout LOS Method: Same as Signalised Intersections.
Roundabout Capacity Model: SIDRA Standard.

Intersection Performance - Annual Values		
Performance Measure	Vehicles	Persons
Demand Flows (Total)	926,087 veh/y	1,111,304 pers/y
Delay	1,861 veh-h/y	2,233 pers-h/y
Effective Stops	490,945 veh-h/y	589,135 pers-h/y
Travel Distance	355,162 veh-mi/y	426,195 pers-mi/y
Travel Time	11,402 veh-h/y	13,682 pers-h/y
Cost	193,677 \$/y	193,677 \$/y
Fuel Consumption	17,726 gal/y	
Carbon Dioxide	167,887 kg/y	
Hydrocarbons	273 kg/y	
Carbon Monoxide	13,296 kg/y	
NOx	417 kg/y	

Processed: Thursday, January 06, 2011 6:19:56 PM Copyright ©2000-2009 Akcelik & Associates Pty Ltd
SIDRA INTERSECTION 4.0.9.973 www.sidrasolutions.com
Project: H:\Pdata\70100312\Traffic\Sidra\Los Altos - Fremont Corridor.sip
8000182, RBF CONSULTING, FLOATING

SIDRA
INTERSECTION